

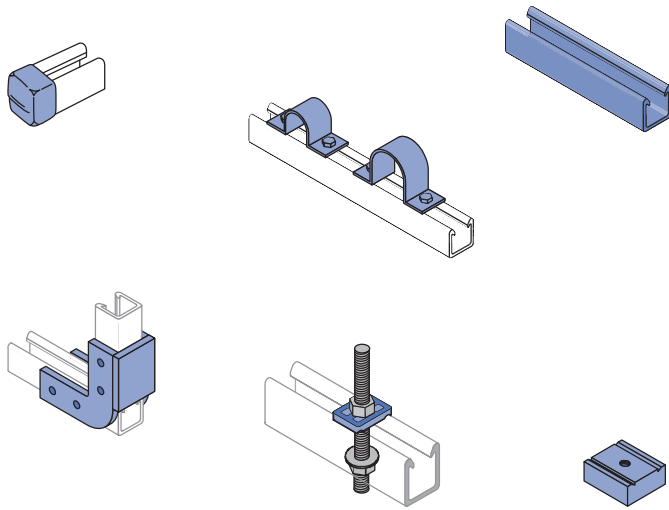

# FIBERGLASS SYSTEMS



- Heavy Duty Channel (Flange Profile) ..... 195
- Light Duty Channel (Flange Profile) ..... 196
- Heavy Duty Channel (SST Profile)..... 197
- Nuts & Hardware ..... 198-200
- Fittings..... 201-202
- Pipe Clamps ..... 203
- Clevis Hangers..... 204
- Beam Clamps ..... 205
- Power Rack Stanchions ..... 205
- Chemical Compatibility ..... 206-207
- Specifications ..... 208

## POLYESTER AND VINYL ESTER MATERIALS

Polyester and vinyl ester channels are manufactured from the pultrusion process and are color coded gray and beige respectively. Components are made by reinforcing a polymer resin (polyester or vinyl ester) with multiple strands of glass filament, alternating layers of glass mat and U.V. resistant surfacing veils. The glass is drawn through the liquid resin, which coats and saturates the fibers. The combination of resin, glass and veil is then continuously guided and pulled (pultruded) through a heated die that determines the shape of the component.

In the die, the resin is cured to form a reinforced part which can be cut to length. The hardened fiberglass pultrusion is reinforced with an internal arrangement of permanently bonded continuous glass fibers to increase its strength.

## INSTALLATION

Fabrication requires just three simple operations: cutting, drilling and sealing as described below.

**Cutting** – Hand held saws, such as hack saws (24 to 32 teeth per inch) are suitable when a few cuts are required. For frequent cutting, a circular power saw with a carbide-tipped masonry blade yields the best results. When using a power saw, dust filter masks, gloves and long sleeve clothing should be worn.

**Drilling** – Any standard twist bit, even when used with battery-powered drills will work well. Carbide-tipped drill bits are recommended.

**Sealing** – To protect against future migration of corrosive elements into the cut sections, all cuts and holes should be properly sealed with clear urethane sealer.

## OPERATING ENVIRONMENT

**Temperature Ranges** – Fiberglass parts are supplied in five different materials covering distinct temperature ranges. The temperature ranges indicated are meant to be used only as a general guideline. Continual exposure to elevated temperatures reduces the strength properties of plastics and glass-reinforced fiberglass. Actual resin test data confirms that a 50% reduction in strength occurs at the extreme high temperature levels.

**Chemical Resistance** – See the chart on page 206 for corrosion resistance. The results are based upon immersion for a 24 hour period. This is typically the “worst case” exposure to corrosion. Less severe contact such as spills, splashes and vapor condensate will exceed the performance results listed in the table.

**Loading** – Channel loading is defined with description of each type of channel. Additional loading and design limitations for fittings and accessories are described in the appropriate section for that part.

Material Temperature Ratings		
Material Code	Low Temp.	High Temp.
E - (Rigid PVC)	-25°F (-31°C)	130°F (54°C)
P - (Poly/Glass)	-35°F (-37°C)	200°F (93°C)
V - (Vinyl/Glass)	-35°F (-37°C)	200°F (93°C)
PU - (Poly)	-40°F (-40°C)	140°F (60°C)
N - (Nylon)	-20°F (-29°C)	150°F (66°C)



1 1/2" System

1 1/4" System

1 3/16" System

Fiberglass System

Special Metals

Prime Angle

Metal Grating

Roofwalk

Index

### Channel - Aickinstrut Flange Profile

**Aickinstrut Flange**

Unistrut fiberglass channels, except the SST series, incorporate the Aickinstrut flange design which provides reliable fastening and interlocking of components and accessories. It is important to note that standard metal framing components such as pipe clamps and strut nuts will not work with the flange design.

**Heavy Duty Aickinstrut Flange Profile**  
1 5/8" x 1 5/8"

**Light Duty Aickinstrut Flange Profile**  
1 1/2" x 1 1/8"

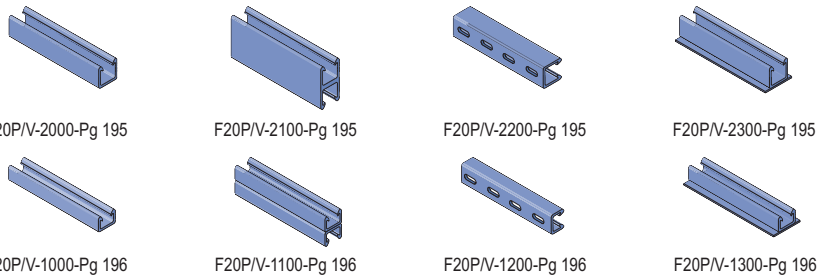

### Channel - SST Profile

**SST Flange**

The Unistrut SST profile is similar to the profile of standard metal channel. The Unistrut SST profile will accommodate standard 1 5/8" metal channel fittings and components. This profile is available in polyester or vinyl ester resin. The Unistrut SST profile is not compatible with the fiberglass pipe clamps and channel nuts shown in this section. Typically, stainless steel clamps and strut nuts (listed elsewhere in this catalog) are used with this profile.

**Heavy Duty SST Profile**  
1 5/8" x 1 5/8"

The Unistrut SST profile will accommodate standard 1 5/8" metal channel fittings and components. This profile is available in polyester or vinyl ester resin. The Unistrut SST profile is not compatible with the fiberglass pipe clamps and channel nuts shown in this section. Typically, stainless steel clamps and strut nuts (listed elsewhere in this catalog) are used with this profile.

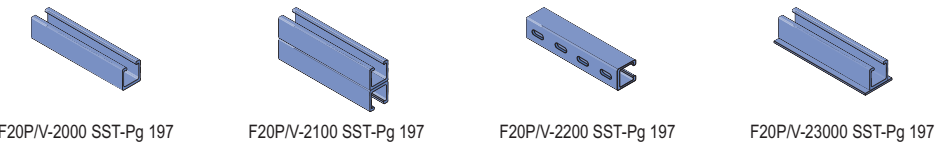

### Hardware & Accessories

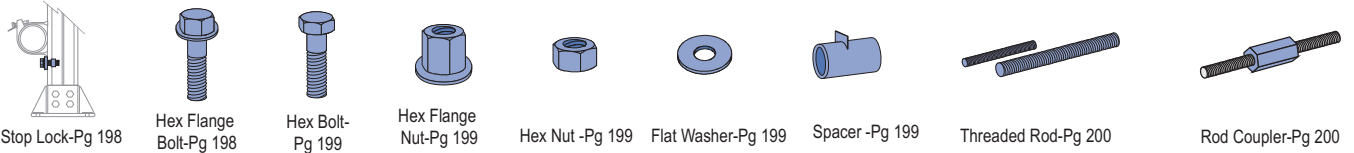
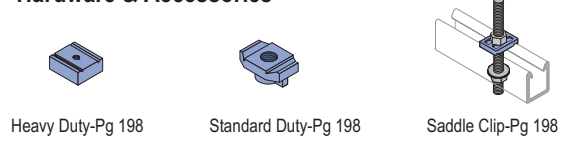

### Fittings

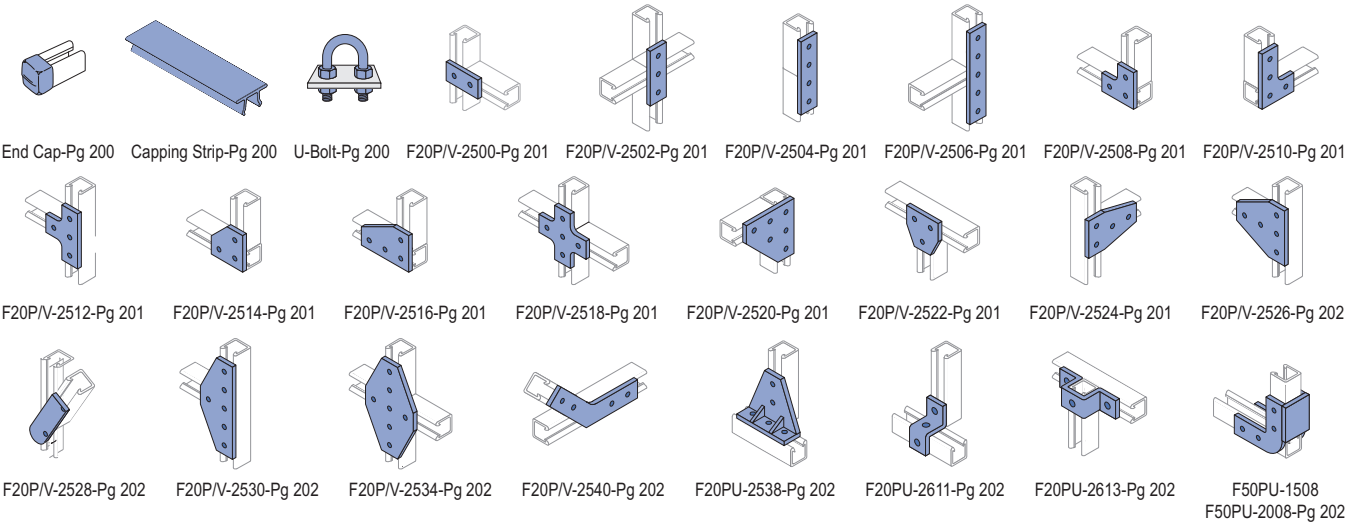

### Pipe Clamps, Beam Clamps and Stanchions

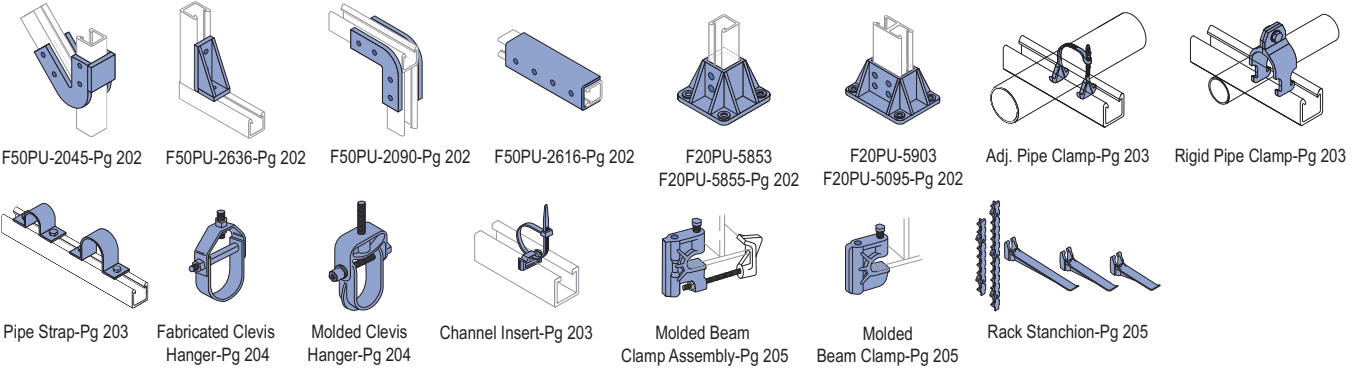

F20P-2000, F20V-2000

HEAVY DUTY SINGLE CHANNEL - AICKINSTRUT FLANGE PROFILE

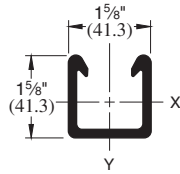
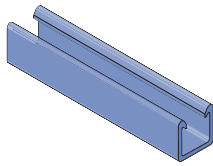

Wt/100 Ft: 82 Lbs(122 kg/100 m)

F20P-2100, F20V-2100

HEAVY DUTY BACK-TO-BACK CHANNEL - AICKINSTRUT FLANGE PROFILE

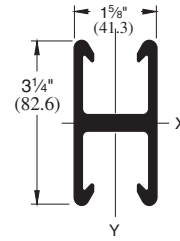
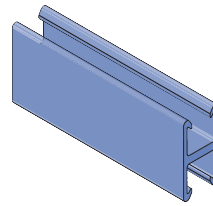

Wt/100 Ft: 164 Lbs (244 kg/100 m)

SECTION PROPERTIES

Part Number	Weight lbs./ft. (kg/m)	Area in <sup>2</sup> (mm <sup>2</sup> )	X - X Axis				Y - Y Axis		
			I in <sup>4</sup> (mm <sup>4</sup> )	R In (mm)	C1 In (mm)	C2 In (mm)	I in <sup>4</sup> (mm <sup>4</sup> )	R In (mm)	C In (mm)
F20P-2000, F20V-2000	0.82	1.06	0.31	0.54	0.7	0.93	0.42	0.63	0.82
F20P-2100, F20V-2100	1.64	2.12	1.77	0.91	1.63	1.63	0.85	0.63	0.82
F20V-2000, F20V-2100	1.2	6.8	12.9	13.7	17.8	23.622	17.5	16.0	20.8
F20P-2000, F20P-2100	2.4	13.7	73.7	23.1	41.4	41.402	35.4	16.0	20.8

FLANGE LOADING

Part Number	Pull-Out Strength* Lbs (kN)
F20V-2000/2100	449 2.0
F20P-2000/2100	360 1.6



\*Values shown represent a 3:1 safety factor

F20P-2200, F20V-2200

SLOTTED CHANNEL

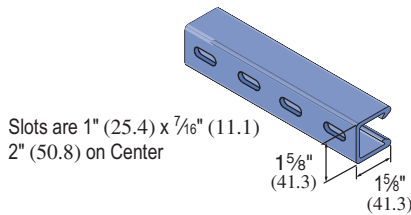

Slots are 1" (25.4) x 7/16" (11.1) 2" (50.8) on Center

Wt/100 Ft: 82 Lbs (122 kg/100 m)

F20P-2300, F20V-2300

W/CONCRETE INSERT

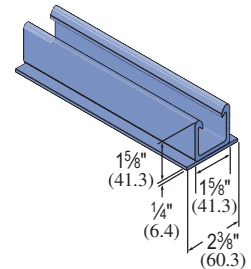
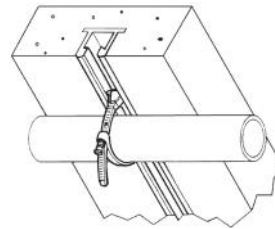

Wt/100 Ft: 88 Lbs (131 kg/100 m)

F20P-2000, F20V-2000

CHANNEL BEAM/COLUMN LOADING

Span In (mm)	Max. Uniform Beam Load (Safety Factor - 3:1)		Uniform Load at Deflection of 1/360 Span		Maximum Column Load Lbs (kN)
	Load Lbs (kN)	Deflection In (mm)	Load Lbs (kN)	Deflection In (mm)	
12	3,561	0.102	1,159	0.033	5,160
304.8	15.8	2.6	5.2	0.8	23.0
18	2,374	0.23	515	0.05	4,704
457.2	10.6	5.8	2.3	1.3	20.9
24	1,781	0.41	290	0.067	4,168
609.6	7.9	10.4	1.3	1.7	18.5
30	1,424	0.64	185	0.083	3,553
762.0	6.3	16.3	0.8	2.1	15.8
36	1,187	0.922	129	0.1	2,859
914.4	5.3	23.4	0.6	2.5	12.7
48	890	1.638	72	0.133	1,636
1,219.2	4.0	41.6	0.3	3.4	7.3
60	712	2.56	46	0.167	1,047
1,524.0	3.2	65	0.2	4.2	4.7
72	594	3.686	32	0.2	727
1,828.8	2.6	93.6	0.1	5.1	3.2

F20P-2100, F20V-2100

CHANNEL BEAM/COLUMN LOADING

Span In (mm)	Max. Uniform Beam Load (Safety Factor - 3:1)		Uniform Load at Deflection of 1/360 Span		Maximum Column Load Lbs (kN)
	Load Lbs (kN)	Deflection In (mm)	Load Lbs (kN)	Deflection In (mm)	
12	5,559	0.028	5,559	0.033	9,454
304.8	24.7	0.7	24.7	0.8	42.1
18	3,706	0.064	2,914	0.05	8,866
457.2	16.5	1.6	13.0	1.3	39.4
24	2,780	0.113	1,639	0.067	8,181
609.6	12.4	2.9	7.3	1.7	36.4
30	2,224	0.177	1,049	0.083	7,405
762.0	9.9	4.5	4.7	2.1	32.9
36	1,853	0.254	730	0.1	6,451
914.4	8.2	6.5	3.2	2.5	28.7
48	1,390	0.452	410	0.133	4,534
1,219.2	6.2	11.5	1.8	3.4	20.2
60	1,112	0.707	262	0.167	2,902
1,524.0	4.9	18.0	1.2	4.2	12.9
72	927	1.018	182	0.2	2,015
1,828.8	4.1	25.9	0.8	5.1	9.0



### F20P-1000, F20V-1000

#### LIGHT DUTY SINGLE CHANNEL - AICKINSTRUT FLANGE PROFILE

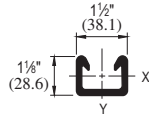
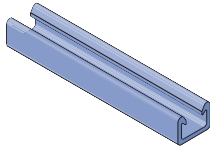

Wt/100 Ft: 47 Lbs (70 kg/100 m)

### F20P-1100, F20V-1100

#### LIGHT DUTY BACK-TO-BACK CHANNEL - AICKINSTRUT FLANGE PROFILE

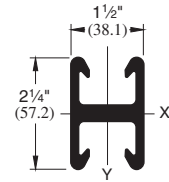
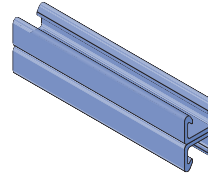

Wt/100 Ft: 94 Lbs (140 kg/100 m)

#### SECTION PROPERTIES

Part Number	Weight lbs./ft. (kg/m)	Area in <sup>2</sup> (mm <sup>2</sup> )	X - X Axis			Y - Y Axis			
			I in <sup>4</sup> (mm <sup>4</sup> )	R In (mm)	C1 In (mm)	C2 In (mm)	I in <sup>4</sup> (mm <sup>4</sup> )	R In (mm)	C In (mm)
F20P-1000, F20V-1000	0.47	0.61	0.1	0.4	0.51	0.62	0.22	0.6	0.75
	0.7	3.9	4.2	10	13	16	9.2	15	19
F20P-1100, F20V-1100	0.94	1.22	0.42	0.59	1.13	1.13	0.44	0.6	0.75
	1.4	7.9	17.5	15	29	28	18.3	15	19.1

#### FLANGE LOADING

Part Number	Pull-Out Strength* Lbs (kN)
F20V-1000/1100	213 1.0
F20P-1000/1100	213 1.0

#### FLANGE LOAD

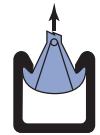

\*Values shown represent a 3:1 safety factor

### F20P-1200, F20V-1200

#### SLOTTED CHANNEL

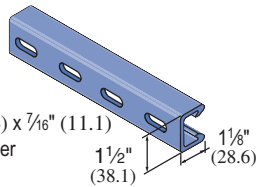

Slots are 1" (25.4) x 7/16" (11.1)  
2" (50.8) on Center



Wt/100 Ft: 47 Lbs (70 kg/100 m)

### F20P-1300, F20V-1300

#### W/CONCRETE INSERT

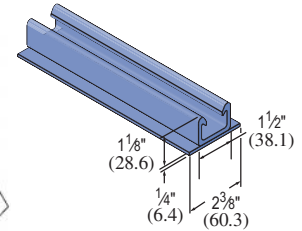
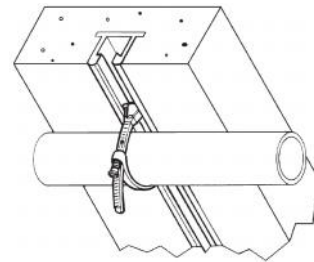

Wt/100 Ft: 53 Lbs (79 kg/100 m)

### F20P-1000, F20V-1000

#### CHANNEL BEAM/COLUMN LOADING

Span In (mm)	Max. Uniform Beam Load (Safety Factor - 3:1)		Uniform Load at Deflection of 1/360 Span		Maximum Column Load Lbs (kN)
	Load Lbs (kN)	Deflection In (mm)	Load Lbs (kN)	Deflection In (mm)	
12	1,629	0.151	359	0.033	2,759
304.8	7.2	3.8	1.6	0.8	12.3
18	1,086	0.340	160	0.050	2,351
457.2	4.8	8.6	0.7	1.3	10.5
24	815	0.605	90	0.067	1,862
609.6	3.6	15.4	0.4	1.7	8.3
30	652	0.945	57	0.083	1,298
762.0	2.9	24.0	0.3	2.1	5.8
36	543	1.360	40	0.100	901
914.4	2.4	34.5	0.2	2.5	4.0
48	407	2.418	22	0.133	507
1,219.2	1.8	61.4	0.1	3.4	2.3
60	326	3.779	14	0.167	324
1,524.0	1.5	96.0	0.1	4.2	1.4
72	272	5.441	10	0.200	225
1,828.8	1.2	138.2	0.0	5.1	1.0

### F20P-1100, F20V-1100

#### CHANNEL BEAM/COLUMN LOADING

Span In (mm)	Max. Uniform Beam Load (Safety Factor - 3:1)		Uniform Load at Deflection of 1/360 Span		Maximum Column Load Lbs (kN)
	Load Lbs (kN)	Deflection In (mm)	Load Lbs (kN)	Deflection In (mm)	
12	3,804	0.082	1,556	0.033	5,961
304.8	16.9	2.1	6.9	0.8	26.5
18	2,536	0.183	691	0.05	5,509
457.2	11.3	4.6	3.1	1.3	24.5
24	1,902	0.326	389	0.067	4,979
609.6	8.5	8.3	1.7	1.7	22.1
30	1,522	0.509	249	0.083	4,375
762.0	6.8	12.9	1.1	2.1	19.5
36	1,268	0.734	173	0.1	3,698
914.4	5.6	18.6	0.8	2.5	16.4
48	951	1.304	97	0.133	2,254
1,219.2	4.2	33.1	0.4	3.4	10.0
60	761	2.038	62	0.167	1,442
1,524.0	3.4	51.8	0.3	4.2	6.4
72	634	2.935	43	0.2	1,001
1,828.8	2.8	74.5	0.2	5.1	4.5

**F20P-2000 SST, F20V-2000 SST**  
HEAVY DUTY SINGLE CHANNEL - SST PROFILE

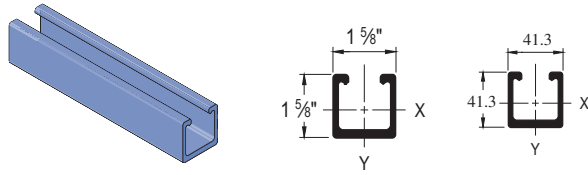

Wt/100 Ft: 82 Lbs (122 kg/100 m)

**F20P-2100 SST, F20V-2100 SST**  
HEAVY DUTY BACK-TO-BACK CHANNEL - SST PROFILE

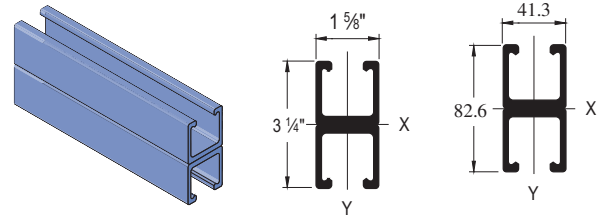

Wt/100 Ft: 164 Lbs (244 kg/100 m)

**F20P-2200 SST, F20V-2200 SST** **SLOTTED CHANNEL**

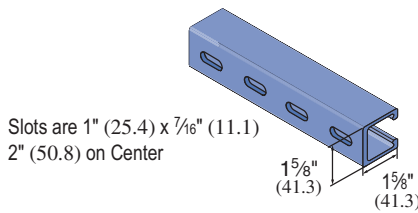

Slots are 1" (25.4) x 7/16" (11.1)  
2" (50.8) on Center

Wt/100 Ft: 82 Lbs (122 kg/100 m)

**F20P-2300 SST, F20V-2300 SST** **W/CONCRETE INSERT**

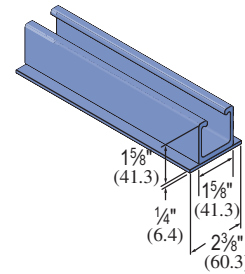

Wt/100 Ft: 88 Lbs (131 kg/100 m)

**NOTE:** Unistrut SST Channel is not compatible with the Unistrut fiberglass pipe clamps and channel nuts shown in this catalog. Metal clamps and channel nuts are compatible with this profile and are shown elsewhere in this catalog.

**F20P-2000 SST, F20V-2000 SST**  
CHANNEL BEAM/COLUMN LOADING

Span In (mm)	Maximum Uniform Beam Load (Safety Fac- tor - 3:1)		Deflection @ Max. Allowable Beam Load		Deflection @ Max. Deflection = 0.25 In (Lbs)		Deflection @ Max. Deflection = 0.50 In (Lbs)		Max. Column Load Lbs (kN)
	Poly Lbs (kN)	Vinyl Lbs (kN)	Poly In (mm)	Vinyl In (mm)	Poly Lbs (kN)	Vinyl Lbs (kN)	Poly Lbs (kN)	Vinyl Lbs (kN)	
12	1,720	2,150	0.07	0.07	—	—	—	—	3,650
304.8	7.6	9.6	1.8	1.8	—	—	—	—	16.2
18	1,150	1,440	0.15	0.17	—	—	—	—	3,370
457.2	5.1	6.4	3.8	4.3	—	—	—	—	15.0
24	860	1,080	0.27	0.3	810	910	—	—	2,960
609.6	3.8	4.8	6.9	7.6	3.6	4.0	—	—	13.2
30	690	870	0.42	0.48	410	460	—	—	2,450
762.0	3.1	3.9	10.7	12.2	1.8	2.0	—	—	10.9
36	580	730	0.61	0.69	240	270	480	540	1,800
914.4	2.6	3.2	15.5	17.5	1.1	1.2	2.1	2.4	8.0
48	430	540	1.07	1.2	100	115	200	230	1,010
1,219.2	1.9	2.4	27.2	30.5	0.4	0.5	0.9	1.0	4.5
60	350	440	1.7	1.91	60	70	120	135	260
1,524.0	1.6	2.0	43.2	48.5	0.3	0.3	0.5	0.6	1.2
72	290	370	2.44	2.78	30	34	60	70	NR
1,828.8	1.3	1.6	62.0	70.6	0.1	0.2	0.3	0.3	NR

**F20P-2100 SST, F20V-2100 SST**  
CHANNEL BEAM/COLUMN LOADING

Span In (mm)	Maximum Uniform Beam Load (Safety Fac- tor - 3:1)		Deflection @ Max. Al- lowable Beam Load		Deflection @ Max. Deflection = 0.25 In (Lbs)		Deflection @ Max. Deflection = 0.50 In (Lbs)		Max. Column Load Lbs (kN)
	Poly Lbs (kN)	Vinyl Lbs (kN)	Poly In (mm)	Vinyl In (mm)	Poly Lbs (kN)	Vinyl Lbs (kN)	Poly Lbs (kN)	Vinyl Lbs (kN)	
12	5,080	6,350	0.04	0.04	—	—	—	—	7,300
304.8	22.6	28.2	1.0	1.0	—	—	—	—	32.5
18	3,390	4,240	0.09	0.1	—	—	—	—	6,740
457.2	15.1	18.9	2.3	2.5	—	—	—	—	30.0
24	2,540	3,180	0.16	0.17	—	—	—	—	5,920
609.6	11.3	14.1	4.1	4.3	—	—	—	—	26.3
30	2,040	2,550	0.24	0.27	—	2,350	—	—	4,900
762.0	9.1	11.3	6.1	6.9	—	10.5	—	—	21.8
36	1,700	2,130	0.35	0.39	1,220	1,370	—	—	3,600
914.4	7.6	9.5	8.9	9.9	5.4	6.1	—	—	16.0
48	1,270	1,590	0.62	0.69	520	590	1,040	1,170	2,020
1,219.2	5.6	7.1	15.7	17.5	2.3	2.6	4.6	5.2	9.0
60	1,020	1,280	0.97	1.09	270	310	540	610	520
1,524.0	4.5	5.7	24.6	27.7	1.2	1.4	2.4	2.7	2.3
72	850	1,070	1.4	1.57	160	180	320	360	NR
1,828.8	3.8	4.8	35.6	39.9	0.7	0.8	1.4	1.6	NR



### HEAVY DUTY CHANNEL NUTS

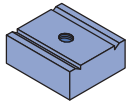

- Heavy duty channel nuts are designed to be used where high thread shear values or spring nuts are required. They can not be used with light duty 1000 series channel or SST profile channel.
- Material: glass-reinforced polyurethane.

### SADDLE CLIPS

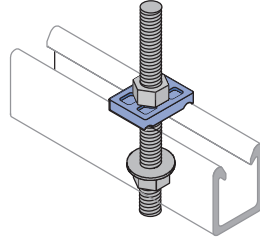

Saddle clips mate with the exterior of the channel flanges and are secured with threaded rods and nuts. Material: glass-reinforced polyurethane.

### STOP-LOCK ASSEMBLIES

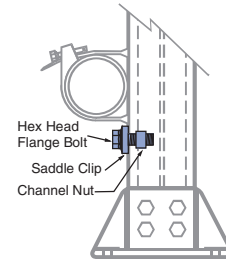

Stop-Lock Assemblies reduce the chance of pipe slippage when running supports vertically and are recommended for applications that are subject to vibration, have regular contact with fluids or are vertically mounted. The Stop-Locks fit both sizes of channel.

Material: glass-reinforced polyurethane.

Part Number	Size	Thread Shear Lbs (kN)*	Torque Ft/Lbs (N•m)	Wt/100 pcs Lbs (kg)
F375PU-CNHD	3/8"-16	1,400 6.23	8 11	5.7 2.6
F500PU-CNHD	1/2"-13	1,400 6.23	8 11	5.3 2.4
F625PU-CNHD	5/8"-11	1,400 6.23	10 14	5.1 2.3
F750PU-CNHD	3/4"-10	1,400 6.23	10 14	4.4 2.0
F10PU-CNMHD	10 mm	1,400 6.23	8 11	5.8 2.6
F12PU-CNMHD	12 mm	1,400 6.23	8 11	5.5 2.5
F16PU-CNMHD	16 mm	1,400 6.23	10 14	5.3 2.4
F20PU-CNMHD	20 mm	1,400 6.23	10 14	4.4 2.0

\*Thread shear values shown represent a 3:1 safety factor.

Part Number	Size (In.)	Wt/100 pcs Lbs (kg)
F200-4226	3/8"	3.5 1.6
F200-4217	1/2"	2.5 1.1
F200-4341	3/4"	3.0 1.4
F200-4342	1"	2.5 1.1

Part Number	Size (in.)	Force Resistance Lbs (kN)*	Torque Ft/Lbs (N•m)	Wt/100 pcs Lbs (kg)
F200-4227	3/8"	200 0.9	7 9	6.3 2.9
F200-4219	1/2"	220 1.0	12 16	6.4 2.9
F200-4343	3/4"***	250 1.1	15 20	11.0 5.0

\* Force resistance values shown represents a 3:1 safety factor.

\*\* Supplied with a heavy duty channel nut for use only with the heavy duty series 2000 channel.

### STANDARD DUTY CHANNEL NUTS



Standard Duty channel nuts are designed for light duty applications that do not require high thread shear values. They can be used with both light duty series 1000 and heavy duty series 2000 fiberglass channel. Not for use with SST profile channel. Material: glass-reinforced polyurethane.

### HEX FLANGE BOLTS

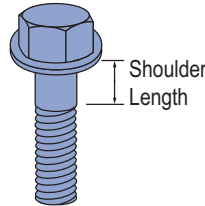

Fiberfast bolts are ideal for mechanical connections that require a high degree of corrosion resistance. The 3/8" diameter fasteners are recommended for all channel fitting mechanical connections. Material: glass-reinforced polyurethane.

Part Number	Size	Thread Shear Lbs (kN)*	Torque Ft/Lbs (N•m)	Wt/100 pcs Lbs (kg)
F250PU-CN	1/4"-20	460 2.05	2 3	1.8 0.8
F312PU-CN	5/16"-18	460 2.05	2 3	1.7 0.8
F375PU-CN	3/8"-16	460 2.05	3 4	1.8 0.8
F500PU-CN	1/2"-13	460 2.05	3 4	1.4 0.6
F10PU-CN	10 mm	460 2.05	3 4	1.7 0.8
F12PU-CN	12 mm	460 2.05	3 4	1.4 0.6
F10PU-CNS	#10 Screw	460 2.05	N/A	1.9 0.9

\*Thread shear values shown represent a 3:1 safety factor.

Part Number	Size (in.)	Thread Shear Lbs (kN)*	Shank Shear Lbs (kN)*	Shoulder Length In (mm)	Torque Ft/Lbs (N•m)	Wt/100 pcs Lbs (kg)
F250PU-075	1/4 x 3/4	110 0.49	210 0.93	Full Thread	0.8 1	.4 0.2
F250PU-100	1/4 x 1	110 0.49	210 0.93	Full Thread	0.8 1	.5 .02
F250PU-150	1/4 x 1 1/2	110 0.49	210 0.93	1/2 12.7	0.8 1	.6 0.3
F500PU-125	1/2 x 1 1/4	450 2.00	870 3.87	Full Thread	8 11	1.0 0.5
F500PU-150	1/2 x 1 1/2	450 2.00	870 3.87	Full Thread	8 11	1.1 .05
F500PU-200	1/2 x 2	450 2.00	870 3.87	3/4 19.1	8 11	1.3 0.6
F500PU-250	1/2 x 2 1/2	450 2.00	870 3.87	Full Thread	8 11	1.6 0.7
F500PU-300	1/2 x 3	450 2.00	870 3.87	1 25.4	8 11	1.8 0.8
F500PU-350	1/2 x 3 1/2	450 2.00	870 3.87	2 3/16 55.6	8 11	2.0 0.9

\*Thread shear values shown represent a 3:1 safety factor.

1 1/2" System  
 1 1/4" System  
 13/16" System  
 Fiberglass System  
 Special Metals  
 Prime Angle  
 Metal Grating  
 Roofwalk  
 Index

HEX BOLTS

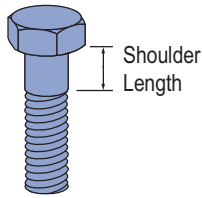

Fiberfast bolts are ideal for mechanical connections that require a high degree of corrosion resistance. The 3/8" diameter fasteners are recommended for all channel fitting mechanical connections. Material: glass-reinforced polyurethane.

Part Number	Size (in.)	Thread Shear Lbs (kN)*	Shank Shear Lbs (kN)*	Shoulder Length In (mm)	Torque Ft/Lbs (N·m)	Wt/100 pcs Lbs (kg)
F375PU-125	3/8 x 1 1/4	250 1.11	470 2.09	Full Thread	3 4	1.0 0.5
F375PU-150	3/8 x 1 1/2	250 1.11	470 2.09	1/4	3 4	1.1 0.5
F375PU-200	3/8 x 2	250 1.11	470 2.09	1/2	3 4	1.3 0.6
F375PU-250	3/8 x 2 1/2	250 1.11	470 2.09	3/4	3 4	1.6 0.7
F375PU-300	3/8 x 3	250 1.11	470 2.09	1	3 4	1.8 0.8
F625PU-125	5/8 x 1 1/4	700 3.11	1,360 6.05	1/4	12 16	2.5 1.1
F625PU-150	5/8 x 1 1/2	700 3.11	1,360 6.05	1/4	12 16	2.8 1.3
F625PU-200	5/8 x 2	700 3.11	1,360 6.05	1/4	12 16	3.2 1.5
F625PU-250	5/8 x 2 1/2	700 3.11	1,360 6.05	1/4	12 16	3.4 1.5
F625PU-300	5/8 x 3	700 3.11	1,360 6.05	1/4	12 16	3.9 1.8
F625PU-350	5/8 x 3 1/2	700 3.11	1,360 6.05	1 1/4	12 16	5.5 2.5

\*Thread shear values shown represent a 3:1 safety factor.

FLAT WASHERS

Material: PVC

Note: PVC washers are recommended for connections that utilize hex nuts and bolts.

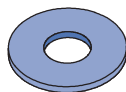

Part Number	Size (in.)	Outside Diameter In (mm)	Wt/100 pcs Lbs (kg)
F250E-999	1/4	0.49 12	0.1 0.05
F375E-999	3/8	1.00 25	0.1 0.05
F500E-999	1/2	1.25 32	0.5 0.2
F625E-999	5/8	1.50 38	0.5 0.2
F750E-999	3/4	1.50 38	1.0 0.5
F1000E-999	1	2.25 57	1.5 0.7

HEX FLANGE NUTS

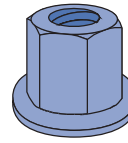

The hex flange nut is preferred for applications that require additional thread engagement (such as with all-thread rod) or maximum thread shear strength. Material: glass-reinforced polyurethane.

Part Number	Size (in.)	Thread Shear Lbs (kN)*	Height In (mm)	Torque Ft/Lbs (N·m)	Wt/100 pcs Lbs (kg)
F375PU-FN-000	3/8-16	500 2.22	0.750 19.1	3 4	0.8 0.4
F500PU-FN-000	1/2-13	1,200 5.34	0.855 21.7	8 11	1.6 0.7
F625PU-FN-000	5/8-11	2,200 9.79	1.220 31.0	12 16	3.5 1.6
F750PU-FN-000	3/4-10	2,900 12.90	1.590 40.4	15 20	5.5 2.5

\*Thread shear values shown represent a 3:1 safety factor.

HEX NUTS

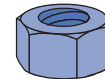

Part Number	Size (in.)	Thread Shear Lbs (kN)*	Height In (mm)	Torque Ft/Lbs (N·m)	Wt/100 pcs Lbs (kg)
F250PU-000	1/4-20	150 0.67	0.218 5.5	0.8 1	0.1 0.05
F375PU-000	3/8-16	460 2.05	0.328 8.3	3 4	0.3 0.1
F500PU-000	1/2-13	800 3.56	0.437 11.1	8 11	0.5 0.2
F625PU-000	5/8-11	1,000 4.45	0.546 13.9	12 16	1.5 0.7

\*Thread shear values shown represent a 3:1 safety factor.

F50PU-500SP

CHANNEL SPACERS

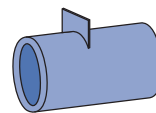

Channel spacers are designed to prevent wall compression under heavy loading conditions. Such loading occurs during the torquing of hardware for channel fittings.

The spacers are designed to be used only with 1 1/8" channels and will accommodate 3/8" and 1/2" bolts. Material: molded from polyurethane

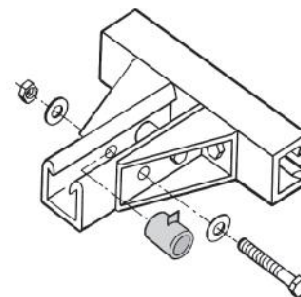

Wt/100 pcs: 2.0 Lbs (.91 kg)



### THREADED ROD

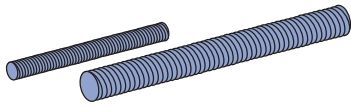

Material: pultruded vinyl ester resin and is gray in color.

\* Thread shear values shown represent a 3:1 safety factor.  
 \*\* Standard lengths are 4' and 8'. The part number shown is for 4' lengths. To order eight foot lengths, add suffix "-96" to part number (Example: F200-3827-96)

Part Number	Size (in.)	Weight Lbs (kg)	Thread Shear Lbs (kN)*	Torque Ft/Lbs (N•m)	Wt/100 pcs 4' in Len. Lbs (kg)
F200-3827	3/8-16	0.07 0.03	415 1.85	5 7	35 15.9
F200-3828	1/2-13	0.12 0.05	570 2.54	10 14	57 25.9
F200-3829	5/8-11	0.18 0.08	1,260 5.60	40 54	91 41.3
F200-3830	3/4-10	0.28 0.13	1,700 7.56	50 68	133 60.3
F200-3831	1-8	0.50 0.23	3,000 13.34	60 81	200 90.7

### A-KONNECTOR ROD COUPLERS

A-Konnectors provide an excellent means for extending FRP all-thread rods beyond their standard lengths. A-Konnectors are manufactured from glass-reinforced polyurethane and are colored gray. A-Konnectors are packaged in bags containing 25 pieces.

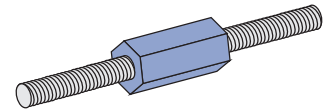

Part Number	Size (in.)	Length In (mm)	Thread Shear Lbs (kN)*	Wt/100 pcs Lbs (kg)
F200-3840	3/8-16	2 1/4 57.2	800 3.56	6.5 2.9
F200-3841	1/2-13	2 1/4 57.2	870 3.87	6.0 2.7
F200-3842	5/8-11	2 1/4 57.2	1,500 6.67	13.0 5.9
F200-3843	3/4-10	2 1/4 57.2	1,500 6.67	11.0 5.0

\* Thread shear values shown represent a 3:1 safety factor.

### FAIC-EC – CHANNEL END CAP

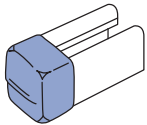

Material: red PVC and designed for 1 1/2" channel. End caps are desired when the ends of the channel need to be enclosed. The cap easily installs by pressing it onto the end of the channel opening.

Wt/100 pcs: 3.4 Lbs (1.5 kg)

### F20E-5000 – CHANNEL CAPPING STRIP

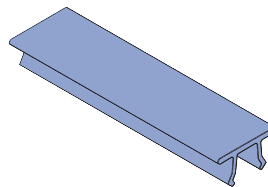

Material: PVC  
 Installs simply by pressing it onto the channel opening. It is designed to be used when a cover is desired for the channel opening (such as concrete embedment channel).

Supplied in 10 foot lengths.

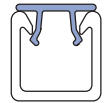

Wt/100 Ft: 5 Lbs (7.4 kg/100 m)

### NONMETALLIC U-BOLTS

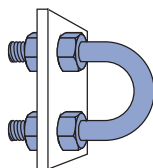
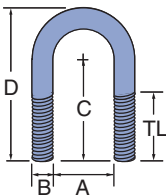

Note: Plate not included. Illustration purpose only

Part Number	Size In	"A" Dim. In (mm)	"B" Dim. In (mm)	"C" Dim. In (mm)	"D" Dim. In (mm)	"TL" Dim. In (mm)	Load Lbs (kN)*	Torque In/Lbs (N•m)	Wt/100 pcs Lbs (kg)
FUB-050	1/2	0.937 23.8	0.375 9.5	1.568 39.8	2.412 61.3	1.25 31.8	135 0.60	40 5	3 1.4
FUB-075	3/4	1.125 28.6	0.375 9.5	1.662 42.2	2.600 66.0	1.25 31.8	135 0.60	40 5	3 1.4
FUB-100	1	1.375 34.9	0.375 9.5	1.787 45.4	2.850 72.4	1.25 31.8	135 0.60	40 5	4 1.8
FUB-125	1 1/4	1.687 42.8	0.375 9.5	1.943 49.4	3.162 80.3	1.25 31.8	135 0.60	40 5	4 1.8
FUB-150	1 1/2	2.000 50.8	0.375 9.5	2.100 53.3	3.475 88.3	1.25 31.8	135 0.60	40 5	5 2.3
FUB-200	2	2.437 61.9	0.500 12.7	2.468 62.7	4.187 106.3	1.50 38.1	135 0.60	80 9	10 4.5
FUB-250	2 1/2	2.937 74.6	0.500 12.7	2.718 69.0	4.687 119.0	1.50 38.1	135 0.60	80 9	11 5.0
FUB-300	3	3.562 90.5	0.500 12.7	3.031 77.0	5.312 134.9	1.50 38.1	135 0.60	80 9	14 6.4
FUB-350	3 1/2	4.062 103.2	0.500 12.7	3.281 83.3	5.812 147.6	1.50 38.1	135 0.60	80 9	15 6.8
FUB-400	4	4.562 115.9	0.500 12.7	3.531 89.7	6.312 160.3	1.50 38.1	135 0.60	80 9	16 7.3
FUB-600	6	6.750 171.5	0.625 15.9	5.750 146.1	9.875 250.8	3.25 82.6	135 0.60	120 14	17 7.7

\*Torque and load values shown represent a 3:1 safety factor.

- Unistrut Nonmetallic U-Bolts provide a corrosion resistant alternative to traditional metallic U-Bolts. They have oversized diameters which allow them to hold steel conduit and plastic pipe. These bolts will outlast stainless steel in most corrosive applications.
- Each U-Bolt comes with two polyurethane hex nuts. Additional nuts and washers can be purchased separately.
- Material: glass-reinforced polyurethane



## CHANNEL FITTINGS

Channel Fittings are required to fabricate structures and are easily attached to Channels with channel nuts and polyurethane fasteners. The fittings are offered in two types; fabricated (cut from flat stock) or molded.

Material (Fabricated Fittings):

Either polyester (P Series) or vinyl ester (V Series) material.

Material (Molded Fittings): All molded fittings with the exception of the post bases are molded in polyurethane.

Note: The drawings for all fittings are shown with the Aickinstrut flange profile, however they can be used with either channel profile.

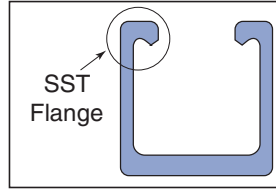
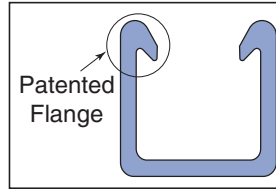

## F20P-2500, F20V-2500

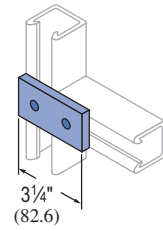

Wt/100 pcs: 12 Lbs (5.4 kg)

## F20P-2502, F20V-2502

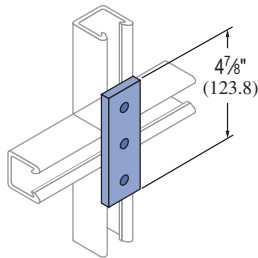

Wt/100 pcs: 17 Lbs (7.7 kg)

## F20P-2504, F20V-2504

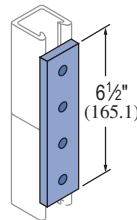

Wt/100 pcs: 24 Lbs (10.9 kg)

## F20P-2506, F20V-2506

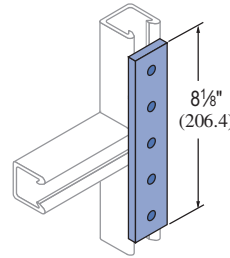

Wt/100 pcs: 32 Lbs (14.5 kg)

## F20P-2508, F20V-2508

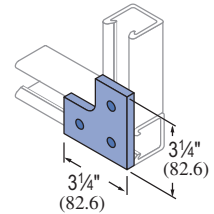

Wt/100 pcs: 17 Lbs (7.7 kg)

## F20P-2510, F20V-2510

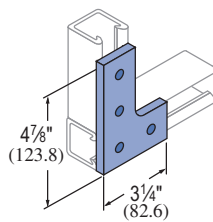

Wt/100 pcs: 25 Lbs (11.3 kg)

## F20P-2512, F20V-2512

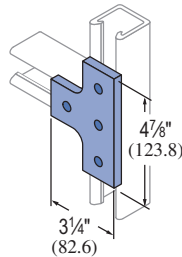

Wt/100 pcs: 26 Lbs (11.8 kg)

## F20P-2514, F20V-2514

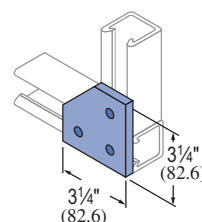

Wt/100 pcs: 20 Lbs (9.1 kg)

## F20P-2516, F20V-2516

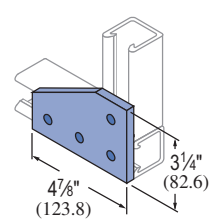

Wt/100 pcs: 32 Lbs (14.5 kg)

## F20P-2518, F20V-2518

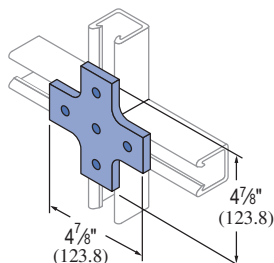

Wt/100 pcs: 33 Lbs (15.0 kg)

## F20P-2520, F20V-2520

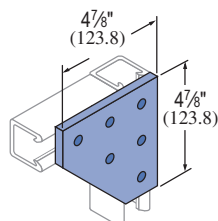

Wt/100 pcs: 45 Lbs (20.4 kg)

## F20P-2522, F20V-2522

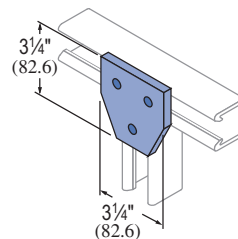

Wt/100 pcs: 21 Lbs (9.5 kg)

## F20P-2524, F20V-2524

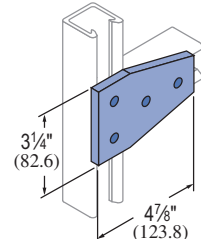

Wt/100 pcs: 32 Lbs (14.5 kg)



1 1/2" System

1 1/4" System

1 3/16" System

Fiberglass System

Special Metals

Prime Angle

Metal Grating

Roofwalk

Index

**F20P-2526, F20V-2526**

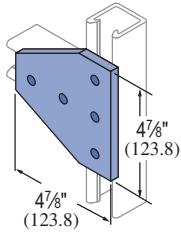

Wt/100 pcs: 45 Lbs (20.4 kg)

**F20P-2528, F20V-2528**

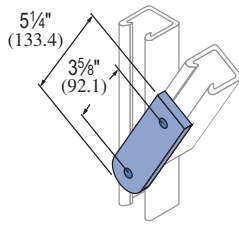

Wt/100 pcs: 20 Lbs (9.1 kg)

**F20P-2530, F20V-2530**

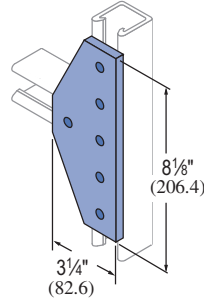

Wt/100 pcs: 50 Lbs (22.7 kg)

**F20P-2534, F20V-2534**

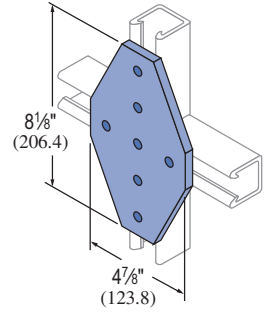

Wt/100 pcs: 77 Lbs (34.9 kg)

**F20P-2540, F20V-2540**

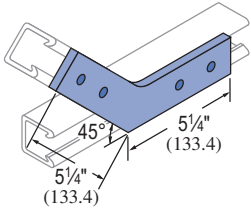

Wt/100 pcs: 41 Lbs (18.6 kg)

**F50PU-2538**

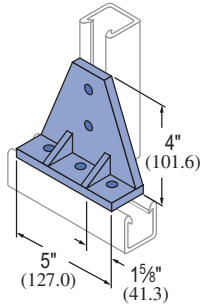

Wt/100 pcs: 57 Lbs (26.0 kg)

**F50PU-2611**

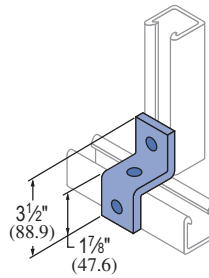

Wt/100 pcs: 9 Lbs (4.1 kg)

**F50PU-2613**

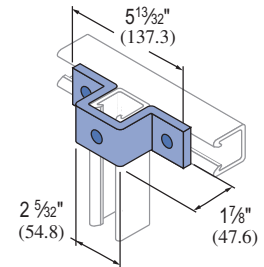

Wt/100 pcs: 16 Lbs (7.3 kg)

**F50PU-1508 (1 1/2"),  
F50PU-2008 (1 5/8")**

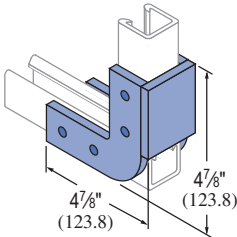

Wt/100 pcs: 27 Lbs (12.2 kg)

**F50PU-2045 (1 5/8")**

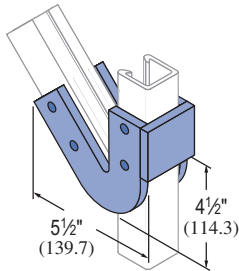

Wt/100 pcs: 35 Lbs (15.9 kg)

**F50PU-2636**

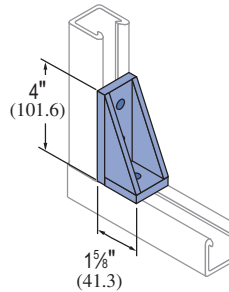

Wt/100 pcs: 14 Lbs (6.4 kg)

**F50PU-2090 (1 5/8")**

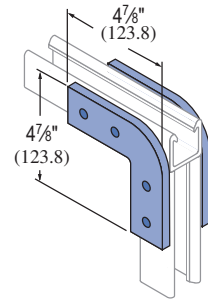

Wt/100 pcs: 35 Lbs (15.9 kg)

**F50PU-2616**

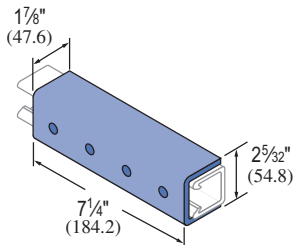

Wt/100 pcs: 51 Lbs (23.1 kg)

**F20PU-5853 (1 5/8"),  
F20PU-5855 (1 1/8")**

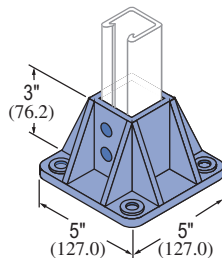

Wt/100 pcs: 71 Lbs (32.2 kg)

**F20PU-5903 (3 1/4"),  
F20PU-5905 (2 1/4")**

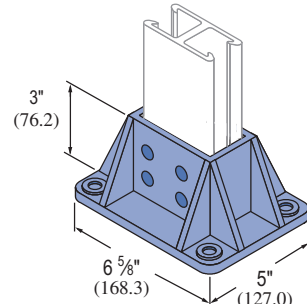

Wt/100 pcs: 86 Lbs (39.0 kg)

ADJUSTABLE PIPE CLAMPS

Unistrut Adjustable Pipe Clamps are manufactured from glass-reinforced polyurethane and are adjustable to accommodate a wide range of outside diameters. They can be utilized with a variety of piping systems including: PVC, fiberglass, copper, rigid steel conduit and PVC coated rigid steel conduit.

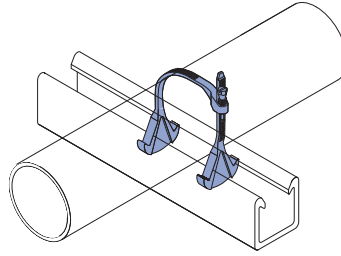

Care should be taken not to exceed 3 ft./lbs. of torque on the adjustable pipe straps.

Part Number	O.D. Pipe Size (in.)	Design Load		Torque Ft/Lbs (N·m)	Wt/100 pcs Lbs (kg)
		Type 1 Lbs (kN)	Type 2 Lbs (kN)		
200-3100	½– 1½	135 (0.6)	65 (0.3)	0.8 (1)	3 (1.4)
200-3110	1½– 2¼	135 (0.6)	65 (0.3)	3 (4)	5 (2.3)
200-3120	2¼– 3¼	145 (0.6)	70 (0.3)	3 (4)	5 (2.3)
200-3130	3 – 4	215 (1.0)	70 (0.3)	3 (4)	8 (3.6)
200-3140	4 – 6½	215 (1.0)	70 (0.3)	3 (4)	10 (4.5)

\*Design loads shown represent a 3:1 safety factor.

RIGID PIPE CLAMPS

Part Number	PVC, Sch. 80 Design Loads*		FRP Bolt		Torque Ft/Lbs (N·m)	Wt/100 pcs Lbs (kg)
	Nominal & Rigid Metal Size (in.)	In (mm)	Type 1 Lbs (kN)	Type 2 Lbs (kN)		
FPCR-050	½	0,840 (21.3)	225 (1.0)	90 (0.4)	3 (4)	3 (1.4)
FPCR-075	¾	1,050 (26.7)	225 (1.0)	90 (0.4)		3 (1.4)
FPCR-100	1	1,315 (33.4)	225 (1.0)	90 (0.4)		4 (1.8)
FPCR-125	1¼	1,660 (42.2)	225 (1.0)	90 (0.4)		5 (2.3)
FPCR-150	1½	1,900 (48.3)	225 (1.0)	90 (0.4)		5 (2.3)
FPCR-200	2	2,375 (60.3)	225 (1.0)	90 (0.4)		5 (2.3)
FPCR-250	2½	2,875 (73.0)	225 (1.0)	90 (0.4)		7 (3.2)
FPCR-300	3	3,500 (88.9)	225 (1.0)	90 (0.4)		10 (4.5)
FPCR-400	4	4,500 (114.3)	300 (1.3)	125 (0.6)		12 (5.4)
FPCR-600	6	6,625 (168.3)	300 (1.3)	125 (0.6)		15 (6.8)
FPCR-800	8	8,625 (219.1)	300 (1.3)	125 (0.6)	18 (8.1)	

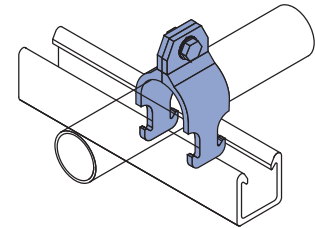

\*Design loads shown represent a 3:1 safety factor.

Rigid Pipe Clamps resemble the more traditional style of pipe clamps and are sized based on the pipe inside diameter or nominal size. Polyurethane clamps are recommended for applications up to 160°F. For high temperature applications (up to 230°F). Care should be taken not to exceed the recommended torque values of the rigid pipe clamps. Material: glass-reinforced polyurethane.

TWO HOLE PIPE STRAPS

Part No.	Dim. A In (mm)	Dim. B In (mm)	Bolt Size (in.)	Material Thick. In (mm)	Design Load		Torque Ft/Lbs (N·m)	Wt/100 pcs Lbs (kg)
					Type 1 Lbs (kN)	Type 2 Lbs (kN)		
FPS200	2,375	6,375	½	¼	135	50	4	14
	60.33	161.93			0.60	0.22	5	6.4
FPS250	2,875	6,875	½	¼	135	50	4	17
	73.03	174.63			0.60	0.22	5	7.7
FPS300	3,500	7,500	½	¼	135	50	4	20
	88.90	190.50			0.60	0.22	5	9.1
FPS350	4,000	8,000	½	¼	135	50	4	33
	101.60	203.20			0.60	0.22	5	15.0
FPS400	4,500	8,500	½	¼	175	60	4	23
	114.30	215.90			0.78	0.27	5	10.4
FPS500	5,563	9,563	½	¼	175	60	4	39
	141.30	242.90			0.78	0.27	5	17.7
FPS600	6,625	10,625	½	¼	175	60	4	39
	168.28	269.88			0.78	0.27	5	17.7
FPS800	8,625	12,625	½	¼	225	125	4	51
	219.08	320.68			1.00	0.56	5	23.1
FPS1000	10,750	15,750	¾	¼	225	125	10	77
	273.05	400.05			1.00	0.56	14	34.9
FPS1200	12,750	16,250	¾	¼	225	125	10	83
	323.85	412.75			1.00	0.56	14	37.6
FPS1400	14,000	18,000	¾	¾	250	150	10	125
	355.60	457.20			1.11	0.67	14	56.7
FPS1600	16,000	20,000	¾	¾	250	150	10	143
	406.40	508.00			1.11	0.67	14	64.9
FPS1800	18,000	23,000	¾	¾	250	150	10	160
	457.20	584.20			1.11	0.67	14	72.6

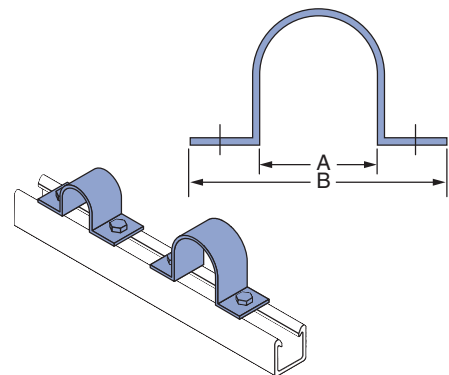

Two Hole Pipe Straps are designed for use in securing pipe, conduit and ducts to Channel. Two hole fiberglass straps can also be used independently from the channel for surface mounting. All sizes of the straps are suitable for load bearing applications.

Material: fire-retardant, glass-reinforced polyester resin.

For extreme chemical environments, the straps can be manufactured from vinyl ester resin. Larger diameter straps for special applications are also available. Contact the factory for pricing and availability of vinyl ester and large diameter straps. Two hole pipe straps should not be torqued above recommended values.

Notes:

- (1) Bolts and channel nuts are sold separately.
- (2) When bolting onto 1½" channel a 1¼" long bolt is req'd.

\*Design loads shown represent a 3:1 safety factor.



### MOLDED CLEVIS HANGERS

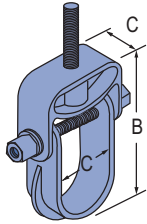

Material: glass-reinforced polyurethane.

\*Design load values shown represent a 3:1 safety factor.

Part Number	Nominal Diameter In (mm)	Max. Pipe O.D. In (mm)	"A" Dim. In (mm)	"B" Dim. In (mm)	"C" Dim. In (mm)	Hanger Rod In (mm)	Load* Lbs (kN)	Wt/100 pcs Lbs (kg)
FCVHPU-100	1/2 - 1	1	1.500	4.25	1.25	1/2	670	29
	12.7 - 25.4	25.4	38.1	108	32	12.7	2.98	13.2
FCVHPU-150	1 1/4 - 1 1/2	1 1/2	2.000	5.14	1.25	1/2	670	40
	31.8 - 38.1	38.1	50.8	131	32	12.7	2.98	18.1
FCVHPU-200	1 1/2 - 2	2	2.500	6.52	1.25	1/2	730	43
	38.1 - 50.8	50.8	63.5	166	32	12.7	3.25	19.5
FCVHPU-400	2 1/2 - 4	4	5.125	10.00	1.50	1/2	1,150	129
	63.5 - 101.6	101.6	130.2	254	38	12.7	5.12	58.5
FCVHPU-600	4 1/2 - 6	6	6.750	12.33	1.50	1/2	1,170	168
	114.3 - 152.4	152.4	171.5	313	38	12.7	5.20	76.2

### FABRICATED CLEVIS HANGERS

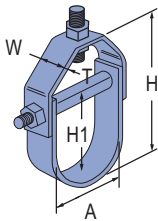

Material: glass-reinforced polyester resin.

\*Design load values shown represent a 3:1 safety factor.

Part Number	Size Range In (mm)	Dimensions - In (mm)					Hanger Rod In (mm)	Trans Rod In (mm)	Spreader Rod O.D. In (mm)	Loads* Lbs (kN)	Wt/100 pcs Lbs (kg)
		A	T	H	H1	W					
F100-1500	1-1 1/2	1/8	2 3/4	1 1/4	1 1/2	1/2	3/8	1/2	60	21	
	25.4 - 38.1	3.2	69.9	47.6	38.1	12.7	9.5	12.7	0.27	9.5	
F100-1501	1 1/2 - 2	1/8	3 1/2	2 3/8	1 1/2	1/2	3/8	1/2	60	25	
	38.1 - 50.8	3.2	88.9	60.3	38.1	12.7	9.5	12.7	0.27	11.3	
F100-1502	2 - 2 5/8	1/8	4 3/4	3	2	1/2	3/8	1/2	90	55	
	50.8 - 66.7	3.2	120.7	76.2	50.8	12.7	9.5	12.7	0.40	24.9	
F100-1503	2 1/2 - 3 1/4	1/8	5 1/2	3 3/8	2	1/2	3/8	1/2	120	57	
	63.5 - 82.6	3.2	139.7	92.1	50.8	12.7	9.5	12.7	0.53	25.9	
F100-1504	3 - 3 3/8	1/8	7	4 1/4	2	1/2	3/8	1/2	160	61	
	76.2 - 98.4	3.2	177.8	108.0	50.8	15.9	9.5	12.7	0.71	27.7	
F100-1505	4 - 5 1/8	13/16	8 1/2	5 3/8	2	1/2	3/8	1/2	250	82	
	101.6 - 130.2	20.6	215.9	142.9	50.8	15.9	9.5	12.7	1.11	37.2	
F100-1506	6 - 7 1/8	13/16	10 1/8	7 1/2	3	1/2	3/8	1/2	300	136	
	152.4 - 181.0	20.6	276.2	190.5	76.2	15.9	9.5	12.7	1.33	61.7	
F100-1507	8 - 9 1/4	1/4	14	9 3/4	3	1/2	3/8	1/2	350	189	
	203.2 - 235.0	6.4	355.6	247.7	76.2	15.9	9.5	12.7	1.56	85.7	
F100-1508	10 - 11 3/8	1/4	18	12	4	1/2	3/8	3/4	450	333	
	254.0 - 288.9	6.4	457.2	304.8	101.6	15.9	12.7	19.1	2.00	151.0	
F100-1509	12 - 13 1/2	1/4	21 1/2	14 3/8	5	1/2	3/8	3/4	600	350	
	304.8 - 342.9	6.4	546.1	358.8	127.0	15.9	12.7	19.1	2.67	158.8	
F100-1510	14 - 15 3/4	1/4	24 1/2	16 1/2	5	3/4	1/2	3/4	700	872	
	355.6 - 400.1	6.4	622.3	419.1	127.0	19.1	12.7	19.1	3.11	395.5	
F100-1511	16 - 18	3/8	27 3/8	19 1/2	6	3/4	3/4	1	750	1,023	
	406.4 - 457.2	9.5	695.3	495.3	152.4	19.1	19.1	25.4	3.34	464.0	
F100-1512	19 - 21	3/8	34 1/2	22 1/2	6	3/4	3/4	1	800	1,673	
	482.6 - 533.4	9.5	876.3	571.5	152.4	19.1	19.1	25.4	3.56	758.9	
F100-1513	21 - 22	1/2	35 1/2	24	6	3/4	3/4	1	850	2,323	
	533.4 - 558.8	12.7	901.7	609.6	152.4	19.1	19.1	25.4	3.78	1,053.7	
F100-1514	22 - 24	1/2	41	28	6	3/4	3/4	1	900	2,973	
	558.8 - 609.6	12.7	1,041.4	711.2	152.4	19.1	19.1	25.4	4.00	1,348.5	

### F200-4101

### UNISERT CHANNEL INSERT

Unisert is a polyurethane nonmetallic insert which can be used with standard cable ties for securing tubing, conduit and cables to standard metal channels. The Unisert works with all 1 1/2" channels that are 13/16" deep or more. One size fits 12, 14 and 16 metal gauge channels.

Note: For use only with metallic channel.

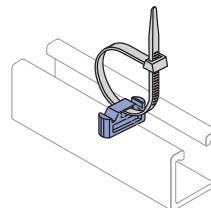

Wt/100 pcs: 1.0 Lbs (.5 kg)

F375PU & F500PU

MOLDED BEAM CLAMPS

Material: glass-reinforced polyurethane

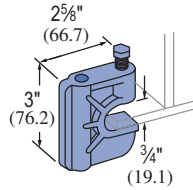

Assembly Part Number	Size In	Thread Shear Lbs (kN)*	Torque Ft/Lbs (N*m)	Wt/100 pcs Lbs (kg)
F375PU-BC	3/8	400 1.78	10 14	30 13.6
F500PU-BC	1/2	400 1.78	10 14	30 13.6

\*Design load values shown represent a 3:1 safety factor.

FRGBC

MOLDED BEAM CLAMP ASSEMBLY

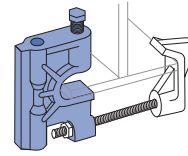

F375PU-BCCLP (3/8")  
Beam Clip Only



Note: Beam clamp clip must be purchased separately. Illustration purpose only

Material: glass-reinforced polyurethane.

Part Number	Size In	Thread Shear Lbs (kN)*	Torque Ft/Lbs (N*m)	Wt/100 pcs Lbs (kg)
FRGBC-1	3/8	500 2.22	10 14	43 19.5
FRGBC-2	1/2	500 2.22	10 14	43 19.5
FRGBC-3	3/4	500 2.22	10 14	43 19.5

\*Design load values shown represent a 3:1 safety factor.

POWER-RACK STANCHIONS

The Power-Rack Stanchion is made entirely from glass-reinforced nylon, these stanchions offer greater corrosion resistance than classical metal stanchions. The interlocking design allows the arm to "lock" into nine different levels on the 14 1/4" stanchions and fourteen on the 17 1/2" stanchion. Glass-reinforced polyurethane stanchions are available as a special order. Contact Unistrut for pricing and availability.  
**Dimensions** – The stanchion back has 3/8" x 1 5/16" holes to accept fasteners for mounting. There are two mounting holes in the 21 3/8" long stanchion and three in the 33 3/16" long stanchion. Thickness at the slotted mounting holes is 1 1/8". The mounting holes are spaced on 12" centers and require 1/2" diameter fasteners.

**Installation** – The Stanchions can be anchored into existing concrete structures using any industrial anchoring system. For new concrete structures, the Stanchions can be mounted to fiberglass concrete embedment channel and attached with 1/2" channel nuts and 1/2"x 3" Fiberfast Bolts.

**Fire Retardance** – Power-Rack materials meet or exceed the requirements of UL94 HB.

**Loading** – The recommended allowable loads on Power-Rack Stanchions vary depending upon the position of the arm. Use these guidelines for a safe, reliable installation:

- Total load on any one arm should not exceed 800 lbs.
- The sum of the loads on an arm multiplied by their distances to the wall stanchion should not exceed 1200 in./lbs.

Example: A cable weighing 200 lbs. is positioned on an arm at a distance of 5" from the wall stanchion.

If the total load is less than 800 lbs and the sum of the load multiplied by their distances to the wall stanchion does not exceed 1200 in./lbs., then the system is adequate. In this case,

Total load (200<800 lbs) = OK  
 Tot. moment (200x5 in. = 1000<1200 in./lbs.) = OK

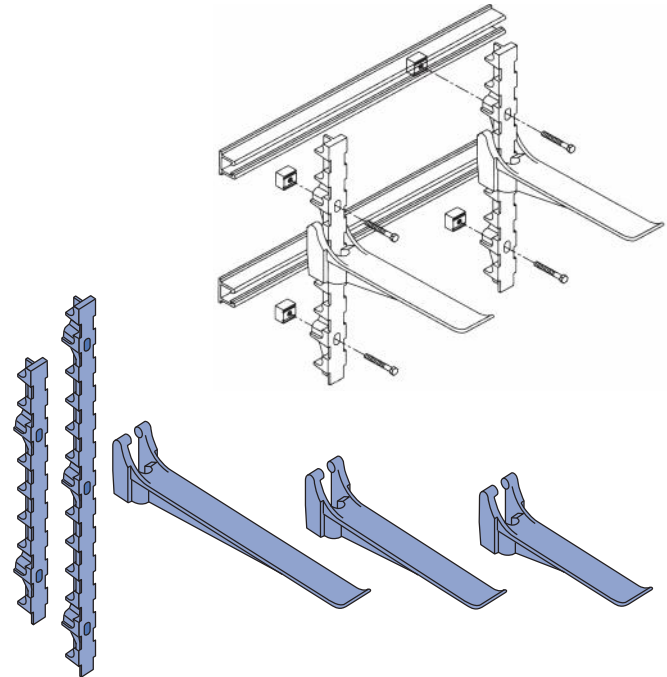

Part No.	Description	Size In (mm)	Wt/100 pcs Lbs (kg)	Load (lbs.)* Lbs (kN)
F20N-ARM08	Arm	8 203.2	100 45.4	800 3.56
F20N-ARM14	Arm	14 1/4 362.0	116 52.6	800 3.56
F20N-ARM17	Arm	17 1/2 444.5	145 65.8	800 3.56
F20N-ARM23	Arm	23 7/8 606.4	186 84.4	800 3.56
F20N-STA21	Stanchion	21 3/8 542.9	149 67.6	N/A
F20N-STA33	Stanchion	33 3/16 846.1	231 104.8	N/A

\*Design load values shown represent a 3:1 safety factor.



**FIBERGLASS CLAMPS DESIGN LOAD INFORMATION**

There are two types of piping system loadings, overhead (Type 1) and vertical (Type 2) as described below. All pipe straps and clamps show the recommended loading for both types of loading.

**Type 1 Overhead Design Load**

The design load shown represents pipes supported below the strut. The design loads shown are based on a minimum ultimate failure safety factor of 3:1.

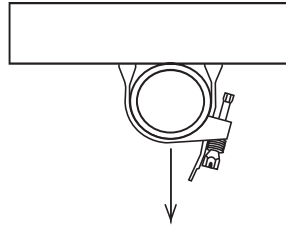

**Type 2 Vertical Design Load**

The design loading shown can be achieved with the addition of a vertical stop lock assembly (Part #F200-4219) installed directly beneath the pipe clamp. The adjacent illustration shows how the vertical stop lock assembly provides additional support for pipe and how it can be used to achieve full Type 2 design loads.

Design loads are based on a minimum clamp slip safety factor of 3:1. It is recommended that stop lock assemblies be used for all vertical pipe support applications.

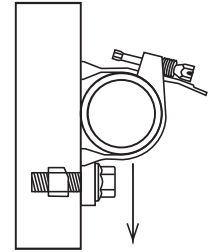

**CHEMICAL COMPATIBILITY TABLE**

Chemical	Series									
	E		P		V		PU		N	
	Rigid PVC		Poly/Glass		Vinyl/Glass		Poly		Nylon	
	70°	160°F	70°	160°F	70°	160°F	70°	160°F	70°	160°F
Acetic Acid, Up to 50%	R	R	R	R	R	R	R	-	nr	nr
Acetone, Up to 10%	nr	nr	nr	nr	nr	nr	R	-	R	R
Aluminum Hydroxide	R	R	R	R	R	R	R	-	nr	nr
Ammonium Hydroxide (Aqueous Ammonia), Up to 5%	R	R	nr	nr	R	R	R	-	-	-
Ammonium Hydroxide (Aqueous Ammonia), Up to 10%	R	R	nr	nr	R	150°	R	-	-	-
Ammonium Hydroxide, Up to 20%	R	R	nr	nr	R	150°	R	-	-	-
Ammonium Nitrate	R	nr	R	R	R	R	R	-	-	-
Ammonium Phosphate	R	R	R	nr	R	R	R	-	-	-
Ammonium Sulfide, saturated	R	R	nr	nr	R	120°	R	-	-	-
Aqua Regia, fumes	nr	nr	nr	nr	R	150°	nr	-	-	-
Benzene	nr	nr	nr	nr	nr	nr	R	R	-	R
Benzoic Acid	R	R	R	R	R	R	R	-	-	-
Bromine, wet gas	R	nr	nr	nr	R	100°	-	-	-	-
Butylene Glycol, Up to 100%	R	R	R	R	R	R	R	-	R	R
Butyric Acid, Up to 50%	nr	nr	R	R	R	R	R	-	-	-
Calcium Hydroxide	R	R	R	nr	R	R	R	-	-	-
Calcium Hypochlorite	R	R	R	nr	R	R	R	-	nr	nr
Chlorine, Dry Gas	nr	nr	nr	nr	R	R	-	-	-	-
Chlorine, Wet Gas	nr	nr	nr	nr	R	R	-	-	-	-
Chlorine, Liquid	nr	nr	nr	nr	nr	nr	-	-	-	-
Chlorine, Water	nr	nr	R	R	R	R	R	-	nr	nr
Chromic Acid, Up to 5%	R	R	nr	nr	R	R	-	-	R	R
Copper Chloride	R	R	R	R	R	R	R	-	-	-
Copper Cyanide	R	R	R	nr	R	R	R	-	-	-
Copper Fluoride	R	R	R	nr	R	R	R	-	-	-
Copper Nitrate	R	R	R	R	R	R	R	-	-	-
Copper Sulfate	R	R	R	R	R	R	R	-	-	-
Dechlorinated Brine Storage	R	R	-	-	R	R	R	-	-	-
Esters, Fatty Acid	nr	nr	R	R	R	R	R	-	-	-
Ferric Chloride	R	R	R	R	R	R	R	-	-	-
Ferrous Chloride	R	R	R	R	R	R	R	-	-	-
Fluoboric Acid	R	R	R	120°	R	R	-	-	-	-
Fluosilicic Acid, Up to 10%	nr	nr	nr	nr	R	R	-	-	nr	nr
Fluosilicic Acid, Up to 32%	nr	nr	nr	nr	R	100°	-	-	-	-

CHEMICAL COMPATIBILITY TABLE

Chemical	Series									
	E		P		V		PU		N	
	Rigid PVC		Poly/Glass		Vinyl/Glass		Poly		Nylon	
	70°	160°F	70°	160°F	70°	160°F	70°	160°F	70°	160°F
Formic Acid, Up to 10%	R	R	nr	nr	R	R	R	-	nr	nr
Formic Acid, Up to 50%	R	R	nr	nr	R	100°	R	-	-	-
Gasoline, Aviation	R	nr	R	nr	R	R	R	-	-	-
Green Liquor, Pulp Mill	R	R	-	-	R	R	-	-	-	-
Hydrochloric Acid, Up to 15%	R	R	R	nr	R	R	R	-	-	-
Hydrochloric Acid, Up to 37%	R	R	R	nr	R	R	R	-	-	-
Hydrofluoric Acid, Up to 10%	R	R	nr	nr	R	150°	-	-	-	-
Hydrofluoric Acid, Up to 20%	R	nr	nr	nr	R	100°	-	-	-	-
Hydrogen Chloride Wet Gas	nr	nr	R	nr	R	R	nr	-	-	-
Hydrogen Sulfide Wet Gas	R	R	R	nr	R	R	R	-	-	-
Lactic Acid	R	R	R	nr	R	R	R	-	-	-
Lead Nitrate	R	R	-	-	R	R	R	-	-	-
Magnesium Hydroxide	R	R	nr	nr	R	R	R	-	R	R
Nickel Sulfate	R	R	nr	nr	R	R	R	-	-	-
Nitric Acid, Up to 5%	R	R	nr	nr	R	150°	R	-	-	-
Nitric Acid, Up to 35%	R	R	nr	nr	R	150°	R	-	-	-
Nitric Acid, Vapor	R	R	nr	nr	R	R	R	-	-	-
Perchloric Acid, Up to 10%	nr	nr	nr	nr	R	150°	R	-	nr	nr
Pickling Liquids, 3-5% H2SO4	R	R	R	R	R	R	R	-	-	-
Phosphoric Acid	R	R	nr	nr	R	R	R	-	nr	nr
Super or Poly (115%, P20%)	R	R	nr	nr	R	R	R	-	-	-
Vapor or Condensate	R	R	nr	nr	R	R	R	-	-	-
Potassium Chloride	R	R	R	R	R	R	R	-	-	-
Potassium Nitrate	R	R	R	R	R	R	R	-	-	-
Potassium Persulfate	R	R	nr	nr	R	R	R	-	-	-
Silver Cyanide, Up to 5%	R	R	nr	nr	R	R	R	-	-	-
Sodium Hydroxide, Up to 25%	R	R	nr	nr	R	150°	R	-	-	-
Sodium Hydroxide, Up to 50%	R	R	nr	nr	R	180°	R	-	R	R
Sodium Hypochlorite, Up to 15%	R	R	nr	nr	R	150°	R	-	nr	nr
Sodium Nitrate	R	R	R	R	R	R	R	-	-	-
Sodium Sulfate	R	R	R	nr	R	R	R	-	-	-
Sodium Sulfide	R	R	nr	nr	R	R	R	-	-	-
Sulfuric Acid, Up to 25%	R	R	R	R	R	R	R	-	nr	nr
Sulfuric Acid, Up to 70%	R	R	nr	nr	R	R	R	-	nr	nr
Sulfuric Acid, Up to 75%	nr	nr	nr	nr	R	120°	R	-	nr	nr
Sulfuric Acid, Up to 80%	nr	nr	nr	nr	nr	nr	nr	-	nr	nr
Sulfuric Acid, Vapor	R	R	R	nr	R	R	R	-	-	-
Trichlorethylene, Fumes	nr	nr	nr	nr	R	120°	R	-	-	-
Trisodium Phosphate	R	R	R	nr	R	R	R	-	-	-
Urea	R	R	R	nr	R	150°	R	-	R	R
Vegetable Oils	R	R	R	R	R	R	R	-	R	R
Vinegar	R	R	R	R	R	R	R	R	R	R
White Liquor, Pulp Mill	R	R	-	-	R	R	R	-	-	-

**Note**

The recommendations contained in this table are made without guarantee of representation as to results. Since the actual use by others is beyond our control, no guarantee, expressed or implied, is made by Unistrut as to effects of such use or results to be obtained nor does Unistrut assume any liability arising out of the use by others of the products referenced in this table. Nor is the information herein to be construed as absolutely complete since additional information may be needed or desirable when particular or exceptional conditions or circumstances exist or because of applicable laws or government regulations. We suggest that you evaluate these recommendations and suggestions in your own laboratory prior to use. Our responsibility for claims arising from breach of warranty, negligence, or otherwise is limited to the purchase price of the material.

**Legend**

- “nr” - “Not Recommended” for use
- “R” - “Recommended”
- “-” - no information available

1 1/2" System  
1 1/4" System  
1 3/16" System  
Fiberglass System  
Special Metals  
Prime Angle  
Metal Grating  
Roofwalk  
Index



## FIBERGLASS SPECIFICATIONS

1 1/2" System

1 1/4" System

1 3/16" System

Fiberglass System

Special Metals

Prime Angle

Metal Grating

Roofwalk

Index

**1.0 SCOPE**

- 1.1 This specification covers the requirements for the Unistrut Nonmetallic Channel Framing System.

**2.0 MATERIAL**

- 2.1 FRP channel shall be of pultruded glass-reinforced polyester or vinyl ester resin having the physical property values listed in this catalog.
- 2.2 Some accessories shall be of injection molded, 40% long glass fiber reinforced polyurethane, or nylon.

**3.0 COMPOSITION**

- 3.1 Glass-reinforced channel shall have a synthetic surfacing veil applied on exterior surfaces to improve weatherability and inhibit ultraviolet degradation. An ultraviolet stabilizer shall be incorporated in the resin formulation to further inhibit ultraviolet degradation.

**4.0 STRUCTURAL DESIGN**

- 4.1 Channel shall incorporate Unistrut's Aickinstrut flange profile design which allows full and positive interlocking contact of channel accessories and prohibits premature flange failure from torqued accessories.
- 4.2 Channel profile dimensions shall be:
- $$1\frac{5}{8}" \times 1\frac{5}{8}" \times \frac{1}{4}" \text{ or}$$
- $$1\frac{1}{2}" \times 1\frac{1}{8}" \times \frac{1}{8}".$$
- 4.3 All 1 5/8" x 1 5/8" channel profiles shall have a minimum pull out resistance of 1,000 pounds when load is applied over a 3/8" long section of the inside flanges.
- 4.4 Channel section lengths shall be supplied in 10' or 20' lengths ( $\pm 1/8"$ ).
- 4.5 Universal Pipe Clamps shall have full interlocking contact with interior channel flanges to maximize pull-out resistance and be adjustable to accommodate a minimum 3/4" variance in piping or conduit O.D. sizes.

**5.0 STANDARDS**

- 5.1 Glass-reinforced channels covered in this specification shall have a flame spread rating of 25 or less when tested per ASTM E84 and meet the requirements of UL 94V0 thereby qualifying them as Class 1 material in the Uniform Building Code.
- 5.2 Glass-reinforced channels covered in this specification shall comply with the requirements of ASTM D 3917 and ASTM D 4385 which govern the dimensional tolerance and visual defects of pultruded shapes.

**6.0 GENERAL**

- 6.1 Unistrut nonmetallic Channel Framing shall be furnished as a system which includes all the necessary fasteners, channel splice plates, brackets, sealants, hangers, pipe clamps, etc.
- 6.2 Nonmetallic fasteners shall be manufactured from long glass fiber reinforced polyurethane to ensure maximum strength and corrosion resistance.
- 6.3 All components of the Unistrut Channel Framing System shall be nonmetallic except where type 316 stainless steel hardware is used as part of the assembly.
- 6.4 The manufacturer shall not have had less than 10 years experience in manufacturing strut systems.
- 6.5 All products are manufactured in the United States of America.