



CATALOG

UNISTRUT[®]

COMMERCIAL

FITTINGS • PIPE CLAMPS • POST BASES • HARDWARE



A PART OF



UNISTRUT® COMMERCIAL

Value-engineered fittings for commercial projects

Unistrut® is the standard for industrial support systems. Many commercial projects do not require the extreme strength it delivers. The marketplace is demanding products designed for sleeker installations.

With that in mind, our engineers have developed Unistrut® Commercial. This expanded product offering will complement our current product line by meeting the need for fittings used in lighter support applications. The line of .197" [5mm] thick fittings for use with 3/8" nuts and bolts is ideal to carry the equipment used in smaller commercial projects.

PRODUCT FEATURES

- Value-engineered fittings for commercial projects
- Specifically designed for use with 3/8" nuts and bolts
- Hole size compatible with metric products
- Many selections available pre-assembled for easier installation (includes pre-installed bolt & channel nut)
- Lower package quantities for smaller commercial jobs
- Electro-galvanized coating per ASTM B663 Zinc plating
- All products have been fully tested and value engineered by Unistrut for optimum efficiency
- Products manufactured to Unistrut quality standards

PRODUCT BENEFITS

- Can be used with any size channel, especially suited for use with 14 gauge and 16 gauge
- Perfect alternative to the 1/2" bolted system when industrial strength is not required
- Eliminates the need for a flat washer with 3/8" bolts
- Streamlined channel nut design offers maximum value
- Value engineered for competitive pricing
- Lighter weight, quicker installation leads to reduced labor costs
- Lower total installed costs

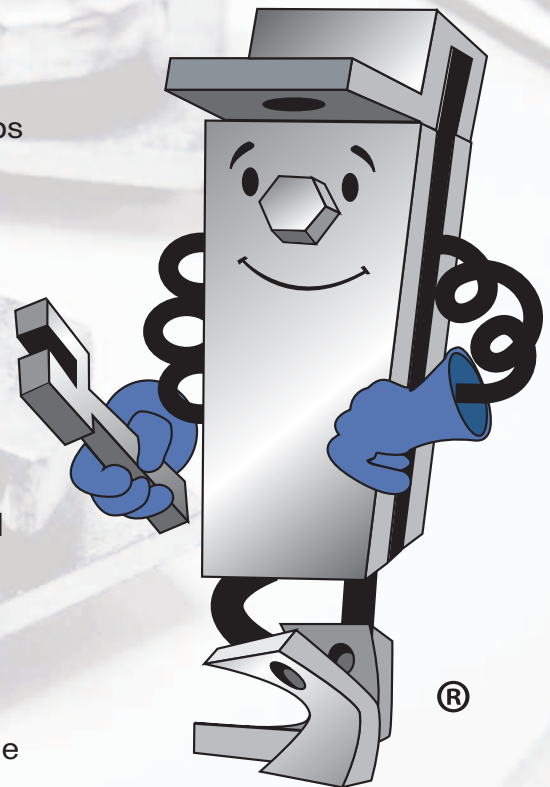

Visit www.unistrut.us for comparative load ratings

Hardware

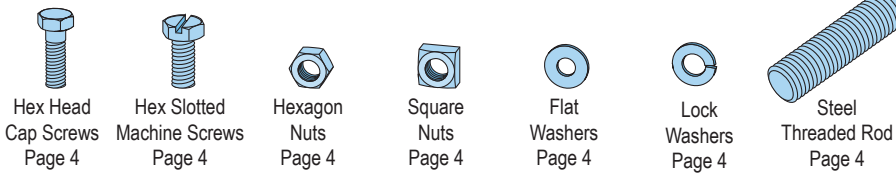

Hex Head Cap Screws Page 4 Hex Slotted Machine Screws Page 4 Hexagon Nuts Page 4 Square Nuts Page 4 Flat Washers Page 4 Lock Washers Page 4 Steel Threaded Rod Page 4

Hardware

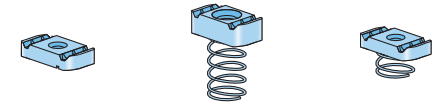

Channel Nut Without Spring Page 4 Channel Nut With Spring Page 4 Channel Nut With Spring Page 4

Pipe/Conduit Clamps

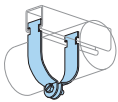

Pipe Clamps for Thin Wall Conduit (E.M.T.)
Pipe Clamps for Rigid Steel Conduit
Page 5

Flat Fittings

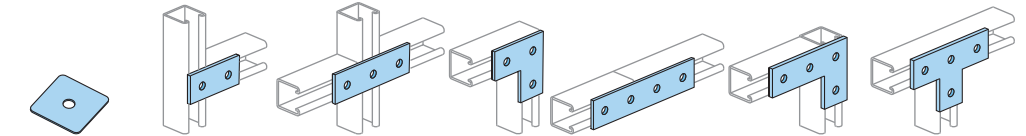

Square Channel Washer Page 6 2 Hole Connector Page 6 3 Hole Connector Page 6 3 Hole Elbow Connector Page 6 4 Hole Connector Page 6 4 Hole Elbow Connector Page 6 4 Hole "T" Connector Page 6

Angle Fittings

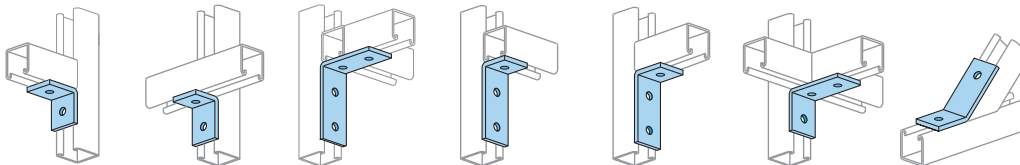

2 Hole 90° Fitting Page 7 2 Hole 90° Fitting Page 7 4 Hole 90° Fitting Page 7 3 Hole Flush 90° Fitting Page 7 3 Hole Flush 90° Fitting Page 7 3 Hole Bench 90° Fitting Page 7 2 Hole Open 45° Fitting Page 7

"Z" Shape Fittings

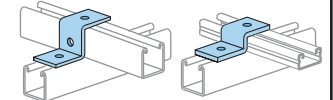

1 1/2" "Z" Connector Page 7 1 3/16" "Z" Connector Page 8

"U" Shape Fittings

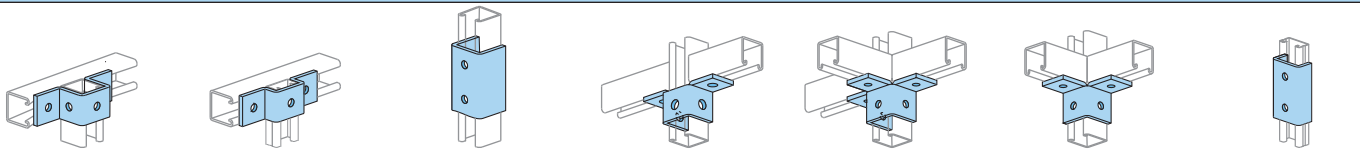

1 5/8" "U" Connector Page 8 1 3/16" "U" Connector Page 8 1 5/8" Channel Splice Page 8 1 5/8" Clevis Wing, 2 Legs Page 8 1 5/8" Clevis Wing, 3 Legs Page 8 1 5/8" 90° Wing Page 8 1 3/16" 2 Hole Channel Splice Page 8

Post Bases



1 5/8" Post Base Page 9 1 5/8" Post Base Page 9

Beam Clamps

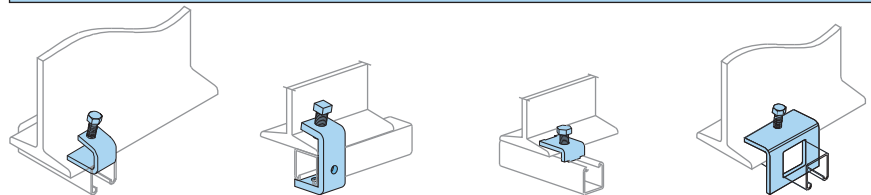

C Shape Channel Beam Clamp Page 10 C Shape HD Channel Beam Clamp Page 10 Top Mount Beam Clamp Page 10 1 5/8" Window Beam Clamp Page 10

Brackets

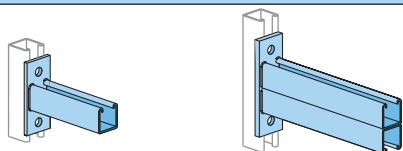

1 5/8" Single Channel Bracket Page 9 1 5/8" Double Channel Bracket Page 9

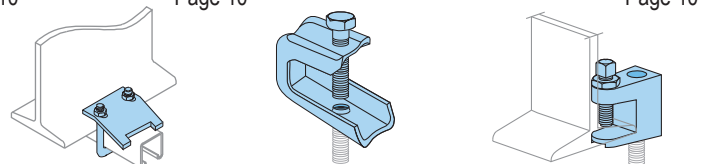

U-Bolt Beam Clamp Page 10 Light Duty Beam Clamp Page 10 Cast Beam Clamp Page 10

HEX HEAD CAP SCREWS

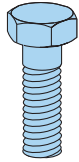

Part No.	Size	Bag Quantity	Estimated Weight (Ea.) Lbs
UCHCS025075EG	1/4" x 3/4"	25	0.017
UCHCS025125EG	1/4" x 1 1/4"	25	0.024
UCHCS037087EG*	3/8" x 7/8"	25	0.044
UCHCS037125EG	3/8" x 1 1/4"	25	0.053
UCHCS050125EG	1/2" x 1 1/4"	25	0.053
UCHCS050150EG	1/2" x 1 1/2"	25	0.044

* Assembled parts employ this bolt so the fitting will work with any channel depth.

HEXAGON NUTS



Part No.	Size	Bag Quantity	Estimated Weight (Ea.) Lbs
UCHXN025EG	1/4"	50	0.006
UCHXN037EG	3/8"	50	0.016
UCHXN050EG	1/2"	25	0.048

FLAT WASHERS



Part No.	Size	Bag Quantity	Estimated Weight (Ea.) Lbs
UCFLW025EG	1/4"	50	0.008
UCFLW037EG	3/8"	50	0.015
UCFLW050EG	1/2"	50	0.035

STEEL THREADED ROD

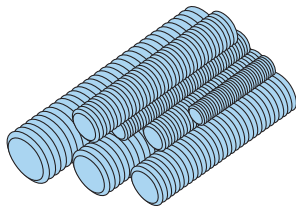

Standard Length 10' (3.0m)

Part No.	Size	Estimated Weight (Ea.) Lbs
ATHR-T-1/4-10EG	1/4" x 20	1.3
ATHR-T-3/8-10EG	3/8" x 16	3
ATHR-T-1/2-10EG	1/2" x 13	5.3

Low Carbon Steel
F_y = 32,000 psi minimum
F_t = 52,000 psi minimum

HEX SLOTTED MACHINE SCREWS

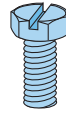

Part No.	Size	Bag Quantity	Estimated Weight (Ea.) Lbs
UCSHS025075EG	1/4" x 3/4"	25	0.017
UCSHS031100EG	5/16" x 1"	25	0.026
UCSHS037125EG	3/8" x 1 1/4"	25	0.030

SQUARE NUTS



Part No.	Size	Bag Quantity	Estimated Weight (Ea.) Lbs
UCSQN025EG	1/4"	50	0.009
UCSQN037EG	3/8"	50	0.027

LOCK WASHERS



Part No.	Size	Bag Quantity	Estimated Weight (Ea.) Lbs
UCLKW025EG	1/4"	50	0.0025
UCLKW037EG	3/8"	50	0.0063
UCLKW050EG	1/2"	50	0.0132

CHANNEL NUT WITHOUT SPRING

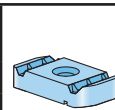

Part No.	Nut Size Thread	Estimated Weight (Ea.) Lbs
UC3006 1/4" EG	1/4" - 20	0.06
UC3008 3/8" EG	3/8" - 16	0.08
UC 3010 1/2" EG	1/2" - 13	0.08

Use with any channel

CHANNEL NUT WITH SPRING

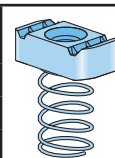

Part No.	Nut Size Thread	Estimated Weight (Ea.) Lbs
UC1006 1/4" EG	1/4" - 20	0.07
UC1008 3/8" EG	3/8" - 16	0.08
UC1010 1/2" EG	1/2" - 13	0.10

Use with Any Channel except P3300, P4100, P4000

Part No.	Nut Size Thread	Estimated Weight (Ea.) Lbs
UC4006 1/4" EG	1/4" - 20	0.07
UC4008 3/8" EG	3/8" - 16	0.075
UC4010 1/2" EG	1/2" - 13	0.08

Use with P3300, P4100, P4000 Channel

PIPE CLAMPS

PIPE CLAMPS FOR THIN WALL CONDUIT (E.M.T.)

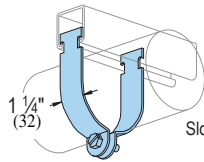

Slotted hex head screw and nut included.

Part No.	Conduit Size In (mm)	O.D. Size In (mm)	Thickness Gauge (mm)	Design Load	Estimated Weight (Ea.) Lbs
UC1425 EG (3/8") AS	3/8 (10)	0.577 (14.7)	16 (1.5)	400	0.09
UC1426 EG (1/2") AS	1/2 (13)	0.706 (17.9)	16 (1.5)	400	0.11
UC1427 EG (3/4") AS	3/4 (19)	0.922 (23.4)	16 (1.5)	400	0.12
UC1428 EG (1") AS	1 (25)	1.163 (29.5)	16 (1.5)	400	0.15
UC1429 EG (1 1/4") AS	1 1/4 (32)	1.510 (38.4)	16 (1.5)	400	0.18
UC1430 EG (1 1/2") AS	1 1/2 (38)	1.740 (44.2)	12 (2.7)	750	0.29
UC1431 EG (2") AS	2 (51)	2.197 (55.8)	12 (2.7)	750	0.33
UC1118 EG (2 1/2") AS	2 1/2 (64)	2.875 (73.0)	12 (2.7)	750	0.4
UC1119 EG (3") AS	3 (76)	3.500 (88.9)	12 (2.7)	750	0.47
UC1120 EG (3 1/2") AS	3 1/2 (89)	4.000 (101.6)	12 (2.7)	750	0.62
UC1121 EG (4") AS	4 (102)	4.500 (114.3)	12 (2.7)	750	0.67

PIPE CLAMPS FOR RIGID STEEL CONDUIT

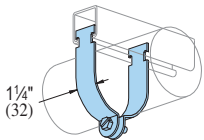

Slotted hex head screw and nut included

Part No.	IPS Pipe or Rigid Conduit Size In	O.D. Size In (mm)	Thickness Gauge (mm)	Design Load	Estimated Weight (Ea.) Lbs
UC1109 EG (3/8") AS	3/8	0.675 (17.1)	16 (1.5)	400	0.1
UC1111 EG (1/2") AS	1/2	0.840 (21.3)	16 (1.5)	400	0.11
UC1112 EG (3/4") AS	3/4	1.050 (26.7)	16 (1.5)	400	0.15
UC1113 EG (1") AS	1	1.315 (33.4)	16 (1.5)	400	0.17
UC1114 EG (1 1/4") AS	1 1/4	1.660 (42.2)	16 (1.5)	400	0.19
UC1115 EG (1 1/2") AS	1 1/2	1.900 (48.3)	12 (2.7)	750	0.29
UC1117 EG (2") AS	2	2.375 (60.3)	12 (2.7)	750	0.34
UC1118 EG (2 1/2") AS	2 1/2	2.875 (73.0)	12 (2.7)	750	0.4
UC1119 EG (3") AS	3	3.500 (88.9)	12 (2.7)	750	0.47
UC1120 EG (3 1/2") AS	3 1/2	4.000 (101.6)	12 (2.7)	750	0.62
UC1121 EG (4") AS	4	4.500 (114.3)	12 (2.7)	750	0.67

SQUARE CHANNEL WASHER

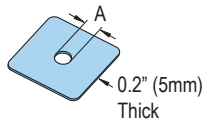

Part No.	"A"	Estimated Weight (Ea.) Lbs
UC1062 EG	1/4"	0.135
UC1063 EG	3/8"	0.13
US1064 EG	1/2"	0.128

2 HOLE CONNECTOR

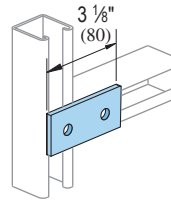

Part No.	Estimated Weight (Ea.) Lbs
UC1065 EG	0.285
UC1065 EG AS	0.553

3 HOLE CONNECTOR

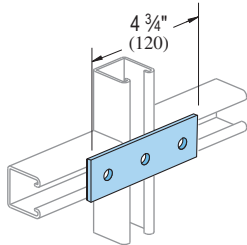

Part No.	Estimated Weight (Ea.) Lbs
UC1066 EG	0.42
UC1066 EG AS	0.822

3 HOLE ELBOW CONNECTOR

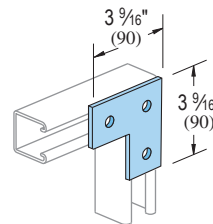

Part No.	Estimated Weight (Ea.) Lbs
UC1036 EG	0.44
UC1036 EG AS	0.842

4 HOLE CONNECTOR

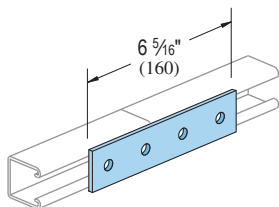

Part No.	Estimated Weight (Ea.) Lbs
UC1067 EG	0.59
UC1067 EG AS	1.126

4 HOLE ELBOW CONNECTOR

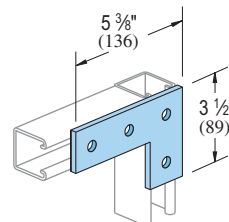

Part No.	Estimated Weight (Ea.) Lbs
UC1380A EG	0.6

4 HOLE "T" CONNECTOR

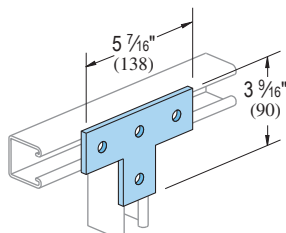

Part No.	Estimated Weight (Ea.) Lbs
UC1031 EG	0.6
UC1031 EG AS	1.136

"AS" parts are furnished assembled. Unless otherwise noted, fittings are .197" (5mm) thick and hole size is 7/16". Assembled components are supplied with 3/8" x 7/8" bolt and channel nut, for use with all channel depths.

ANGLE, "Z" AND "U" SHAPE FITTINGS

2 HOLE 90° FITTING

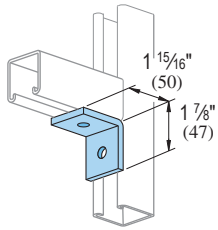

Part No.	Estimated Weight (Ea.) Lbs
UC1026 EG	0.3
UC1026 EG AS	0.568

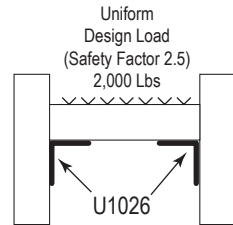

2 HOLE 90° FITTING

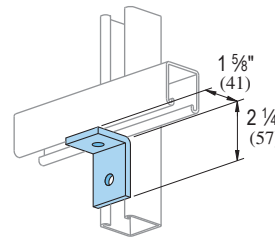

Part No.	Estimated Weight (Ea.) Lbs
UC1068 EG	0.3
UC1068 EG AS	0.568

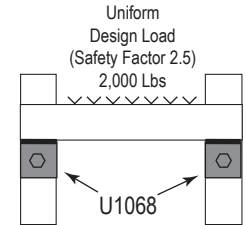

4 HOLE 90° FITTING

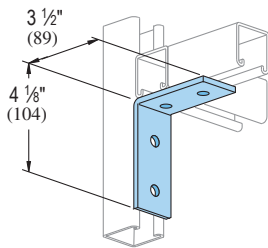

Part No.	Estimated Weight (Ea.) Lbs
UC1325 EG	0.61
UC1325 EG AS	1.146

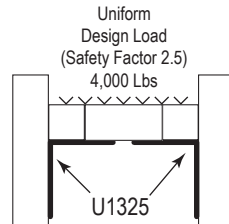

3 HOLE FLUSH 90° FITTING

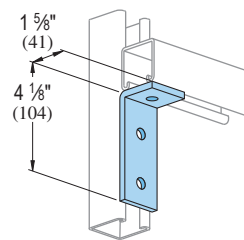

Part No.	Estimated Weight (Ea.) Lbs
UC1326 EG	0.46
UC1326 EG AS	0.86

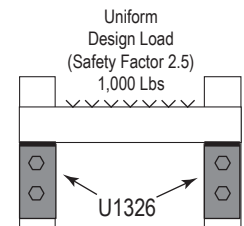

3 HOLE FLUSH 90° FITTING

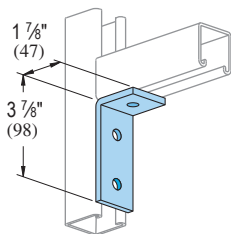

Part No.	Estimated Weight (Ea.) Lbs
UC1346 EG	0.46
UC1346 EG AS	0.86

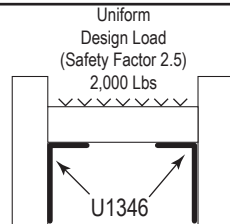

3 HOLE BENCH 90° FITTING

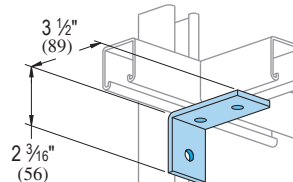

Part No.	Estimated Weight (Ea.) Lbs
UC1458 EG	0.46
UC1458 EG AS	0.86

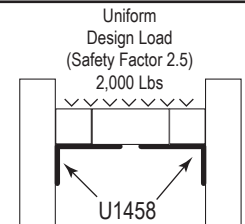

2 HOLE OPEN 45° FITTING

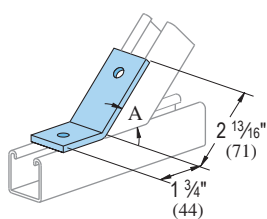

Part No.	Estimated Weight (Ea.) Lbs
UC1546 EG	0.46
UC1546 EG AS	0.73

1 5/8" "Z" CONNECTOR

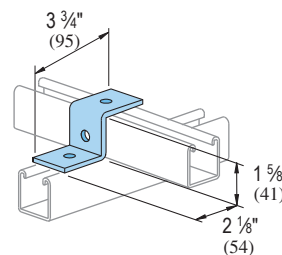

Part No.	Estimated Weight (Ea.) Lbs
UC1045 EG	0.43

"AS" parts are furnished assembled. Unless otherwise noted, fittings are .197" (5mm) thick and hole size is 7/16". Assembled components are supplied with 3/8" x 7/8" bolt and channel nut, for use with all channel depths.

1 5/8" "U" CONNECTOR

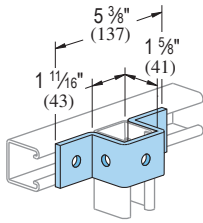

Part No.	Estimated Weight (Ea.) Lbs
UC1047 EG	0.69

1 5/8" CHANNEL SPLICE

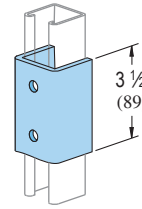

Part No.	Estimated Weight (Ea.) Lbs
UC1376 EG	1

1 5/8" CLEVIS WING, 2 LEGS

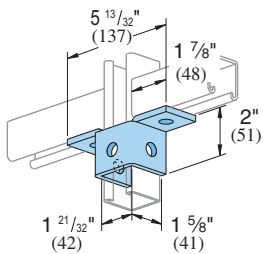

Part No.	Estimated Weight (Ea.) Lbs
UC2345 EG	0.73

1 5/8" CLEVIS WING, 3 LEGS

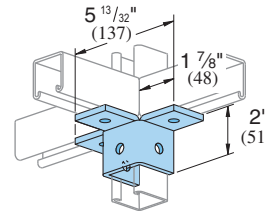

Part No.	Estimated Weight (Ea.) Lbs
UC2227 EG	0.89

1 5/8" 90° WING

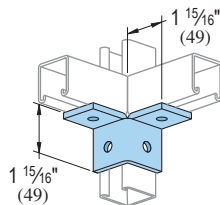

Part No.	Estimated Weight (Ea.) Lbs
UC2223 EG	0.6

1 3/16" "Z" CONNECTOR

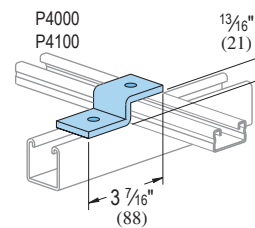

Part No.	Estimated Weight (Ea.) Lbs
UC4045 EG	0.37

1 3/16" "U" CONNECTOR

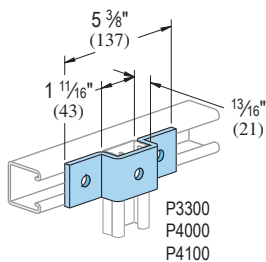

Part No.	Estimated Weight (Ea.) Lbs
UC4047 EG	0.56

1 3/16" 2 HOLE CHANNEL SPLICE

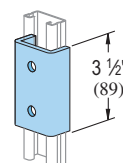

Part No.	Estimated Weight (Ea.) Lbs
UC4376 EG	0.67

"AS" parts are furnished assembled. Unless otherwise noted, fittings are .197" (5mm) thick and hole size is 7/16". Assembled components are supplied with 3/8" x 7/8" bolt and channel nut, for use with all channel depths.

POST BASES & BRACKETS

1 5/8" POST BASE

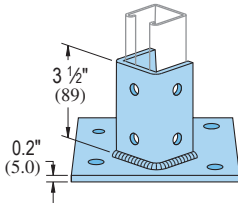

Part No.	Estimated Weight (Ea.) Lbs
UC2072A EG	2.93
UC2072A SQ EG	2.93

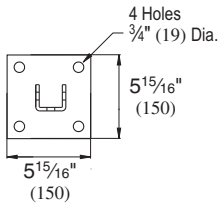

UC2072A SQ

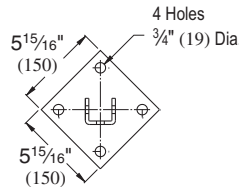

UC2072A

1 5/8" POST BASE

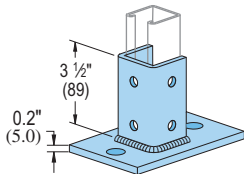

Part No.	Estimated Weight (Ea.) Lbs
UC2941 EG	2.82
UC2942 EG	2.82

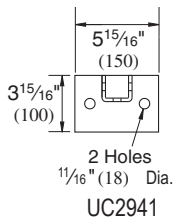

UC2941

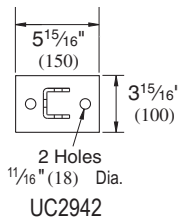

UC2942

1 5/8" SINGLE CHANNEL BRACKET

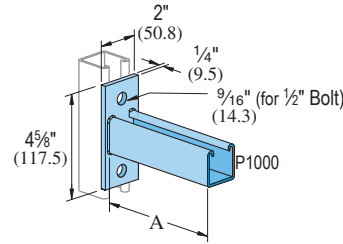

Part No.	"A"	Estimated Weight (Ea.) Lbs
UC2945 EG	12"	2.9
UC2946 EG	18"	4
UC2947 EG	24"	5

1 5/8" DOUBLE CHANNEL BRACKET

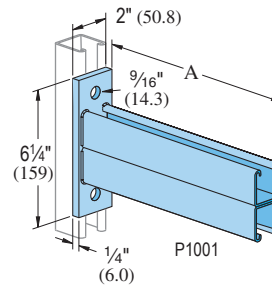

Part No.	"A"	Estimated Weight (Ea.) Lbs
UC2542 EG	12"	5
UC2543 EG	18"	6.9
UC2544 EG	24"	8.8

"AS" parts are furnished assembled. Unless otherwise noted, fittings are .197" (5mm) thick and hole size is 7/16". Assembled components are supplied with 3/8" x 7/8" bolt and channel nut, for use with all channel depths.

C SHAPE CHANNEL BEAM CLAMP

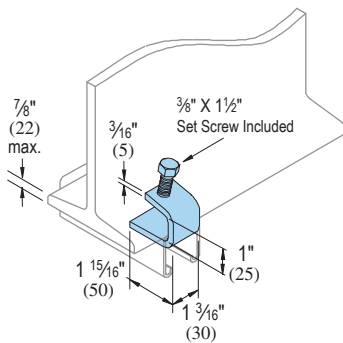

Part No.	Estimated Weight (Ea.) Lbs
UC1272S EG	0.29

Total Design Load
(when Used in Pairs) 750 Lbs
Safety Factor 5

C SHAPE HD CHANNEL BEAM CLAMP

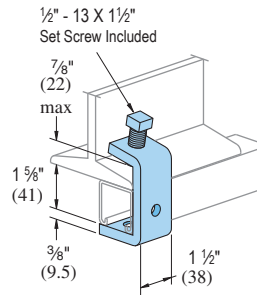

Part No.	Estimated Weight (Ea.) Lbs
UC1985S	0.52

Total Design Load
(when Used in Pairs) 900 Lbs
Safety Factor 5

TOP MOUNT BEAM CLAMP

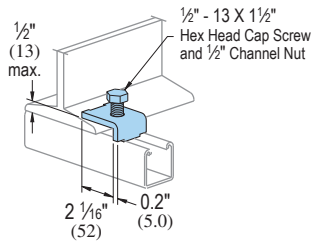

Total Design Load
(when Used in Pairs) 1,400 Lbs
Safety Factor 5

Part No.	Estimated Weight (Ea.) Lbs
UC1386 EG AS	0.2

1 5/8" WINDOW BEAM CLAMP

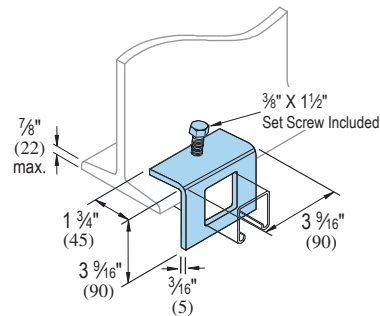

Part No.	Estimated Weight (Ea.) Lbs
UC1796S EG	0.69

U-BOLT BEAM CLAMP

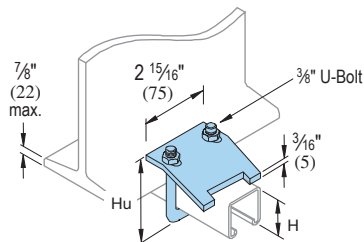

Mild steel "U" bolts are zinc plated.

Total Design Load
(when Used in Pairs)
UC2785 -- 1,500 Lbs
UC2786 -- 900 Lbs

Safety Factor 5

Part No.	"H"	"Hu"	Estimated Weight (Ea.) Lbs
UC2785 EG	1 5/8"	3 3/8"	0.7
UC2786 EG	3 1/2"	5"	0.79

LIGHT DUTY BEAM CLAMP

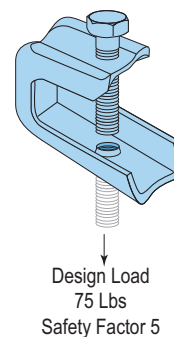

Part No.	Estimated Weight (Ea.) Lbs
UC2893 EG	0.14

CAST BEAM CLAMP

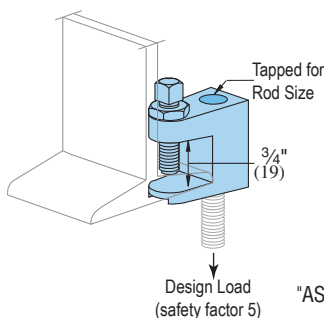

Part No.	Tapped Hole Size	Design Load Lbs.	Estimated Wt. (Ea.) Lbs
UC2894-25 EG	1/4" - 20	250	0.23
UC2894-37 EG	3/8" - 16	500	0.95
UC2894-50 EG	1/2" - 13	1,000	1.95

"AS" parts are furnished assembled. Unless otherwise noted, fittings are .197" (5mm) thick and hole size is 7/16". Assembled components are supplied with 3/8" x 7/8" bolt and channel nut, for use with all channel depths.

The technical specification for UNISTRUT COMMERCIAL products shall include all pertinent elements of the Guide Specification as provided on page 19 of the Unistrut #17 catalog including:

- Part 1 General
 - 01.01 Scope of Work
 - 01.02 Quality Assurance
 - 01.03 Submittals
 - 01.04 Product Delivery, Storage and Handling
 - 01.05 Guarantee

- Part 2 Products
 - 2.01 Acceptable Manufacturers
 - 2.02 Materials
 - 2.03 Finishes, A2 Electro-galvanized (EG) and A4 Hot-Dip Galvanized (HG)

In addition to the aforementioned Product requirements the following product specifications are included for UNISTRUT COMMERCIAL metal framing fittings and components:

- 2.04 Design
 - 2.04.1 Gage: The metal framing fittings shall be light weight and high strength. The standard connection fitting gage shall be 5mm (.197 nominal) gage.
 - 2.04.2 Standard fitting connections: Metal Framing fittings shall be provided with fastener connection holes no larger than 7/16" nominal dia. to accommodate 3/8" diameter fasteners.
 - 2.04.3 Other Connections: Where 1/2" connections are required for trapeze drops or other similar installations, reduced gage nuts shall be employed, however nut performance in slip resistance and pull-out strength shall be equivalent to the MFMA standard requirement (latest edition) for the bolt thread size required.
 - 2.04.4 Ergonomics: Box quantities for metal framing fittings shall weigh no more than 30 lbs maximum.

- 2.05 Products: Manufacture, Testing and Certification
 - 2.05.1 The metal framing system shall be constructed from press and roll-formed products produced by a single manufacturer. Products produced through other processes by third party partners (castings, fasteners, etc) shall be tested and certified by the metal framing fittings manufacturer.
 - 2.05.2 All channel nuts shall be case hardened employing a heat treat and oil quench process to ensure consistent slip resistance.
 - 2.05.3 All metal framing fittings shall be load rated by specific part numbers. The test set-up shall be with force applied vertical-down, beam load testing with fittings used in pairs. Test results including test set-up pictorials for fittings shall be available for submittal and review at the discretion of the owner. Allowable design loads shall be established based upon minimum safety factors applied to ultimate failure loads:
 - Standard bolted connection fittings2.5 S.F.
 - Pipe Clamps.....5 S.F.
 - Beam Clamps.....5 S.F.
 - Channel Nuts3 S.F.Certified test results shall be available and provided if requested by the Customer.

- 2.06 Packaging
 - 2.06.1 All products including welded channel brackets shall be shipped to Customers in boxes, clearly labeled with part numbers, manufacturer's information, country of origin and quantity per box.
 - 2.06.2 Box quantities shall be reduced from the standard packaging arrangements of full gage (1/4") standard metal framing fittings to accommodate tradesmen working at heights.

- Part 3 Execution
 - 3.01 Examination
 - 3.02 Installation
 - 3.03 Cleanup
 - 3.04 Protection

16100 S. Lathrop Ave.
Harvey, IL 60426
TOLL FREE / 800-882-5543
FAX / 708-339-7814

www.unistrut.us



Columbia-MBF™



KAF-TECH®



UNISTRUT®



TECTRONTube®

RAZOR RIBBON®

UNISTRUT Construction



SprinkFLEX®



FLEXHEAD INDUSTRIES®