

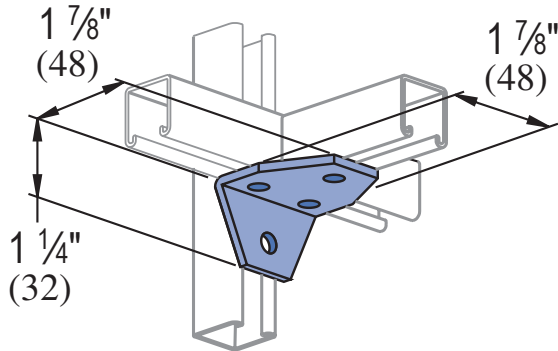

P6579

Wt/100 pcs: 15 Lbs (6.8 kg)



Standard Dimensions for 1 3/16" (21mm) width series channel fittings (Unless Otherwise Shown on Drawing)

Hole Diameter: 9/32" (7mm); Hole Spacing - From End: 1 3/32" (10mm); Hole Spacing - On Center: 1 1/16" (27mm); Width: 1 3/16" (21mm); Thickness: 1/8" (3mm)

MATERIAL

Channels are accurately and carefully cold formed to size from low-carbon strip steel.

STEEL: PLAIN - 19 Gauge (1.0 mm) ASTM A1008

STEEL: PRE-GALVANIZED

19 Gauge (1.0 mm) ASTM A653 GR 33

All nuts are manufactured from mild steel bars conforming to ASTM A1011 SS Grade 33.

Fittings are made from hot rolled, pickled and oiled steel plate or strip and conform to ASTM A1011 SS GR 33.

FINISHES

Channels are available in: Perma-Green III (GR), electro-galvanized (EG), Pre-galvanized (PG), conforming to ASTM A653 GR 33 and plain (PL).

Nuts are available in plain or electro-galvanized (EG) finish.

Fittings are available in Perma-Green III, electrogalvanized (EG) with zinc electrolytically to commercial standards ASTM B653-G90 Type III SC1; or plain (PL).

Project: _____

Approval Stamp:

Architect / Engineer: _____

Date: _____ **Phone:** _____

Contractor: _____

Address: _____

Notes 1: _____

Notes 2: _____