

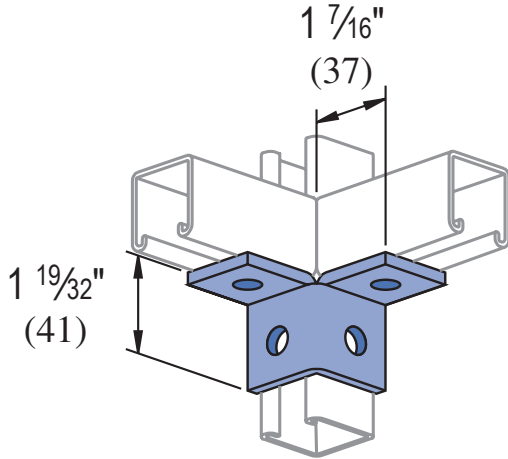

A2223

Wt/100 pcs: 34 Lbs (15.4 kg)



Standard Dimensions for 1 1/4" (32 mm) width series channel fittings (Unless Otherwise Shown on Drawing)

Hole Diameter: 13/32" (10mm); Hole Spacing - From End: 5/8" (16 mm); Hole Spacing - On Center: 1 1/2" (38= mm); Width: 1 1/4"(32mm); Thickness: 3/16" (5mm)

MATERIAL

Unistrut channels are accurately and carefully cold formed to size from low-carbon strip steel.

STEEL: PLAIN

- 14 Gauge (1.9 mm), ASTM A1011 SS GR 33
- 19 Gauge (1.0 mm) ASTM A1008

STEEL: PRE-GALVANIZED

- 14 Gauge (1.9 mm) ASTM A653 GR 33,
- 19 Gauge (1.0 mm) ASTM A653 GR 33

Channel nuts are manufactured from mild steel bars conforming to ASTM A576, GR 1015, and are case hardened.

Fittings are made from hot rolled, pickled and oiled steel plate or strip and conform to ASTM A1011 SS GR 33.

Many framing channels are available in special metal on request. Consult factory for ordering information.

FINISHES

All channels and fittings are available in: Perma-Green III (GR), Pre-galvanized (PG), conforming to ASTM A653 GR 33 and plain (PL).

Nuts are available in plain or electro-galvanized (EG) finish.

Fittings are available in Perma-Green III (GR) or plain (PL).

Project: _____

Approval Stamp:

Architect / Engineer: _____

Date: _____ **Phone:** _____

Contractor: _____

Address: _____

Notes 1: _____

Notes 2: _____