

The right way to attach almost anything to metal roofs!

# S-5!<sup>®</sup>

## The Right Way!

### CorruBracket<sup>™</sup>

CorruBracket<sup>™</sup> can be used to mount almost anything to corrugated metal roofing and is compatible with 7/8" and 3/4" corrugated roofing. No messy sealants to apply! No chance for leaks! The CorruBracket comes with factory-applied butyl sealant already in the base, and the S-5!<sup>®</sup> patented reservoir conceals the sealant, preventing UV degradation.

Installation is simple! CorruBracket is mounted directly into the supporting structure of the roof, i.e. roof decking, wood or steel purlins, or trusses. No surface preparation is necessary; simply wipe away excess oils and debris, peel the release paper, align, and apply. Secure through the pre-punched holes using the appropriate screws for the supporting structure.

CorruBracket is so strong, it will even support heavy-duty applications like snow retention. For corrugated profiles, the CorruBracket is the perfect match for our ColorGard<sup>®</sup> snow retention system. CorruBracket is economical and facilitates quick and easy installation.

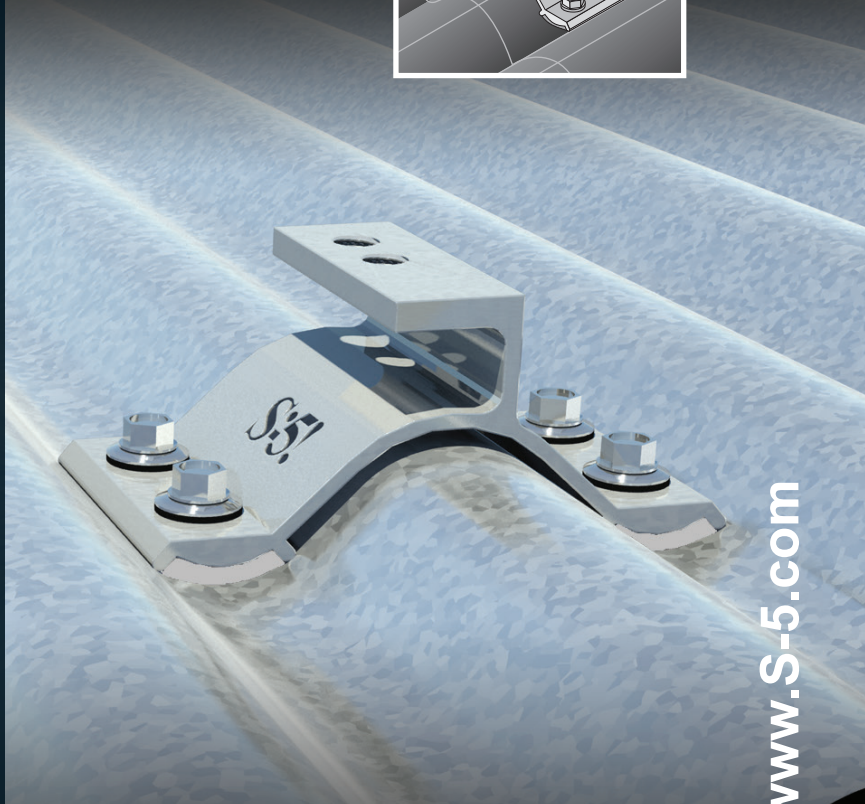
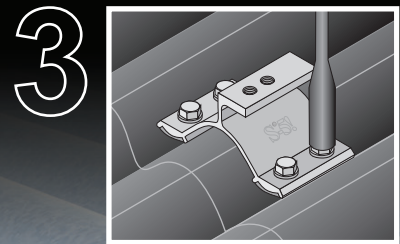
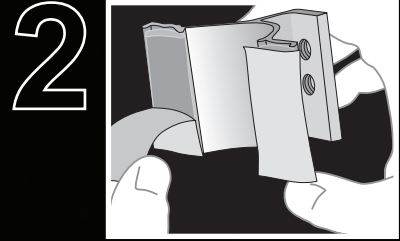
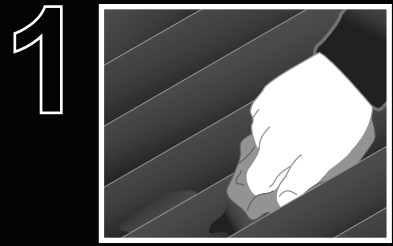

S-5!<sup>®</sup> CorruBracket<sup>™</sup> is the right way to attach almost anything to 7/8" and 3/4" corrugated roofing, including PV via DirectAttached<sup>™</sup> or rail methods.

CorruBracket<sup>™</sup>

888-825-3432 | [www.S-5.com](http://www.S-5.com)

# S-5!<sup>®</sup>

The Right Way!

CorruBracket™ is extremely versatile. It can be used for almost any attachment need on 7/8" and 3/4" corrugated metal roofing. No messy sealants to apply. The factory-applied butyl sealant waterproofs and makes installation a snap!

Each CorruBracket™ comes with factory-applied butyl sealant in the base. CorruBracket is compatible with most common metal roofing materials. For design assistance, ask your distributor, or use our web-based calculator at [www.S-5.com](http://www.S-5.com) for job-specific system engineering and design of your next snow retention project. Also, please visit our website for more information including CAD details, metallurgical compatibilities and specifications.

The CorruBracket has been tested for load-to-failure results on wood decking, and metal and wood purlins. The independent lab test data found at [www.S-5.com](http://www.S-5.com) can be used for load-critical designs and applications. S-5!<sup>®</sup> holding strength is unmatched in the industry.

## Example Profile

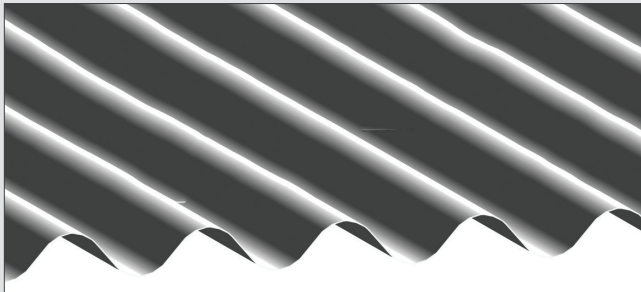

## CorruBracket™

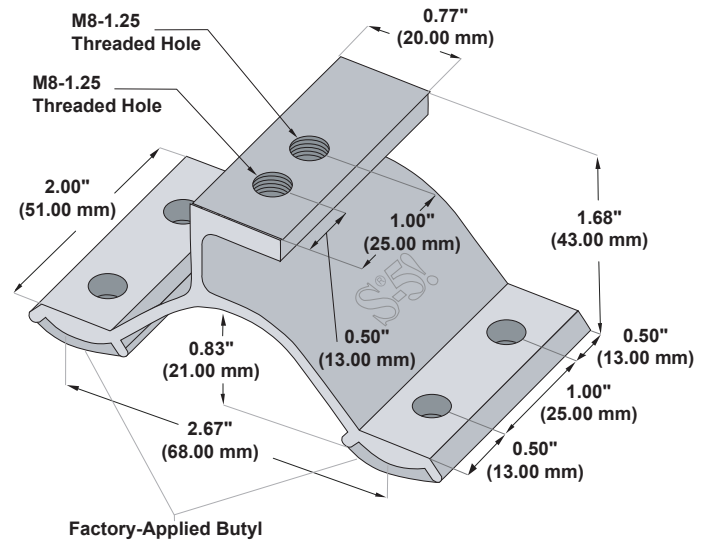

Please note: All measurements are rounded to the second decimal place. Contact your distributor for information about hardware requirements.

## Example Applications

### S-5-PV Kit (DirectAttached™ or Rail)

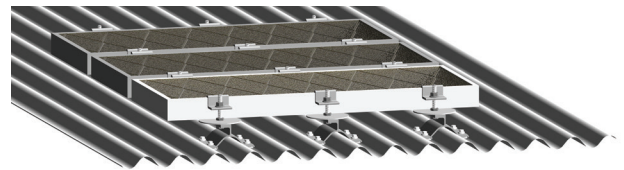

### ColorGard®

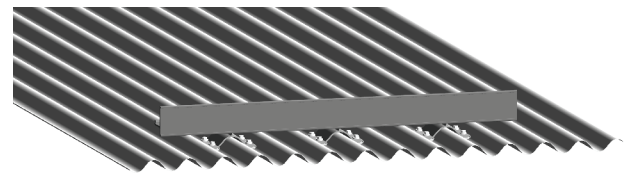

### S-5!<sup>®</sup> Warning! Please use this product responsibly!

Products are protected by multiple U.S. and foreign patents. For published data regarding holding strength, bolt torque, patents and trademarks visit the S-5! website at [www.S-5.com](http://www.S-5.com).

Copyright 2013, Metal Roof Innovations, Ltd. S-5! products are patent protected. S-5! aggressively protects its patents, trademarks, and copyrights. Version 120517.

Distributed by



**UNISTRUT**  
SERVICE COMPANY

24400 Sperry Drive  
Cleveland OH 44145  
[www.unistrutohio.com](http://www.unistrutohio.com)  
Phone: 440-348-9460