

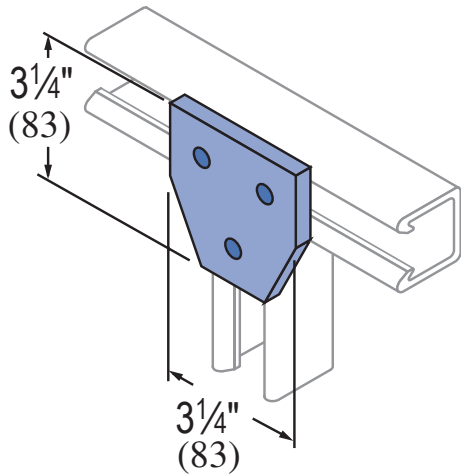

20P-2522, 20V-2522

Wt/100 pcs: 21 Lbs (9.5 kg)



**POLYESTER AND VINYL ESTER MATERIALS**

Polyester and vinyl ester channels are manufactured from the pultrusion process and are color coded gray and beige respectively. Components are made by reinforcing a polymer resin (polyester or vinyl ester) with multiple strands of glass filament, alternating layers of glass mat and U.V. resistant surfacing veils. The glass is drawn through the liquid resin, which

coats and saturates the fibers. The combination of resin, glass and veil is then continuously guided and pulled (pultruded) through a heated die that determines the shape of the component.

In the die, the resin is cured to form a reinforced part which can be cut to length. The hardened fiberglass pultrusion is reinforced with an internal arrangement of permanently bonded continuous glass fibers to increase its strength.

<b>Project:</b> _____ <b>Architect / Engineer:</b> _____ <b>Date:</b> _____ <b>Phone:</b> _____ <b>Contractor:</b> _____ <b>Address:</b> _____ _____ <b>Notes 1:</b> _____ _____ <b>Notes 2:</b> _____ _____	<b>Approval Stamp:</b>      
---	--